

# PROSTHETIC MANUAL CONOWELD

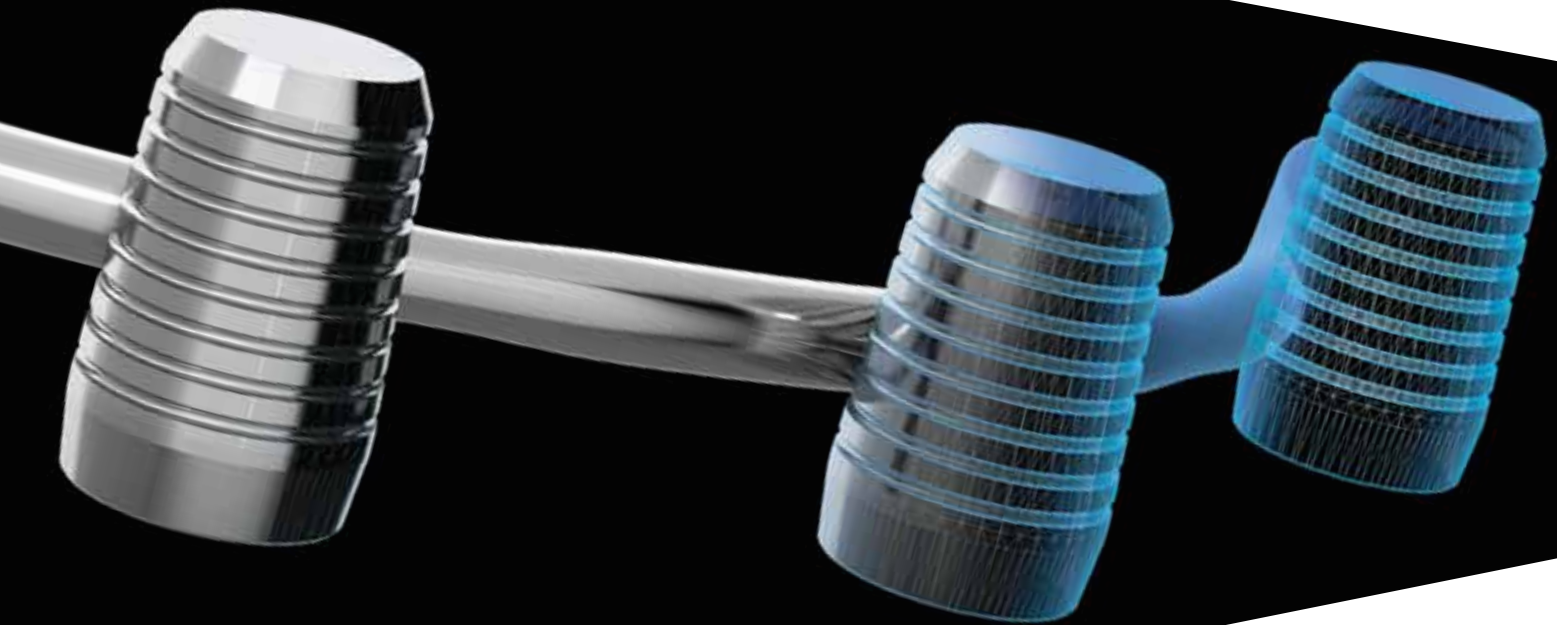

# PROSTHETIC MANUAL TABLE OF CONTENTS



Connection platform

6



Use Protocols

18



Prosthetic components

8

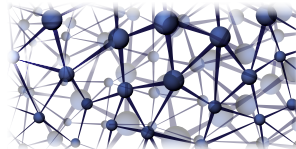

General indications

34



Instruments

14



Bibliography

41

Sweden & Martina develops and manufactures implant systems that offer excellent clinical performance hand in hand with perfect cosmetic results. The prosthetic components available reflect the company's updating and development capacity and cover all the requirements of prosthodontists and laboratories. The same quality obtained for the production of implants is also guaranteed for the prosthesis: from abutments to screws, every single part is milled with certified CNC machines and not moulded. Training courses, continuous refresher courses and extensive assistance distinguish the service and reliability that have made Sweden & Martina a leader in the Italian implant market.





**PREMIUM SWITCHING PLATFORM**  
The morphology is the result of clinical findings.



**KOHNO SWITCHING PLATFORM**  
Characterised by tapering accentuated by the bevel for the Switching Platform.



**Premium  
Kohno**

The logo consists of two overlapping rounded rectangular shapes, one green and one blue, each containing horizontal white lines. To the right of these shapes, the word 'Premium' is written in green and 'Kohno' in blue.

**PREMIUM Ø 3.30 MM**  
Dedicated to intraforaminal sectors and useful with thin bone crests, or to replace upper lateral incisors.



**SHORTY IMPLANTS**  
Intended for bone crests with reduced vertical development.

**KOHNO STRAIGHT**  
The same connection combined  
with a conical morphology extends  
the range of use of the family.



**PREMIUM STRAIGHT**  
The implant with 16 years  
of clinical history.



Shelta

**SHELTA SL**  
The large thread studied to obtain  
the maximum primary stability.



**SHELTA STANDARD**  
Three different diameters with the  
same prosthetic connection.



## COLLEX connection

The COLLEX connection, supported by 16 years of clinical studies, is characterised by a wide internal hexagon, synonym of high prosthetic stability, guaranteed also by the collar that penetrates the posts, giving to the prosthetic structure an excellent and unique strength.

This interlocking solution gives stability and solidity to the implant-prosthesis complex, while also aiding the correct distribution of masticatory loads.

The COLLEX connection performs the same stabilising function regardless of the emergence of the implant, which may be straight in the case of Straight implants or bevelled in the case of SP implants (Switching Platform).

The external collar of the COLLEX has the function of guide and engagement of the Easy Insert driver, the patented driver for the insertion of Premium implants, which guarantees the total preservation of the angles of the internal connection during the surgical procedure, very important condition for a correct prosthetic phase.



COLLEX connection  
Premium implants  
Ø 3.30 mm

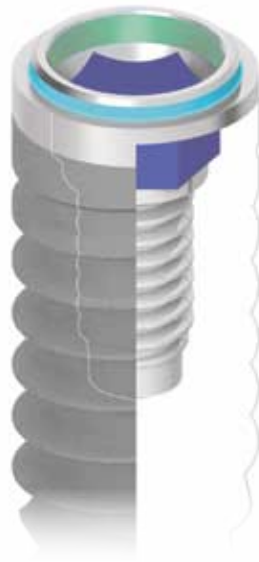

COLLEX connection  
Premium Kohno Straight implants  
Ø 3.80, 4.25, 5.00 mm

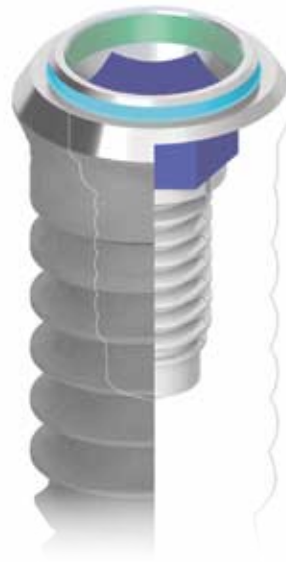

COLLEX connection  
Premium Kohno SP implants  
Ø 3.80, 4.25, 5.00 mm



COLLEX connection  
Shelta implants  
Ø 3.80, 4.25, 5.00 mm

The strength properties of the COLLEX connection are also documented by a study carried out by the group of Prof. Covani, in which this connection was compared with another internal hexagon connection, but without the external prosthetic collar; the results highlighted values 25% higher in terms of robustness and stability of the prosthetic COLLEX compared to the connection without collar.

(Covani U., Ricci M., Tonelli P., Barone A. - An evaluation of new designs in implant-abutment connections: a finite element method assessment - Implant Dentistry Volume 22, Number 3 2013).

### IMPORTANT WARNING

With the same implant diameter, the implants with Straight emergence and with Switching Platform emergence use the same prosthetic components: for this reason no distinction will be made in this manual between the two different emergences.



# Switching Platform

The Switching Platform protocol, a prosthetic technique widely supported by scientific literature, aims to distance the implant-post junction from the crestal bone. This result may be achieved either by designing ad-hoc an enlarged emergence at the level of the neck of the implant, or by using posts with a diameter smaller than the implant platform, when the geometry of the connection is the same for all the sizes in the range. Premium Kohno SP implants are specifically designed for use in prosthetic rehabilitations according to the Switching Platform protocol: the bevel around the connecting platform distances the prosthetic junction both vertically and horizontally. The morphology of the neck of the implant is also very useful for obtaining an excellent primary stability. The Switching Platform technique used in these implants is incorporated in the fixture morphology.

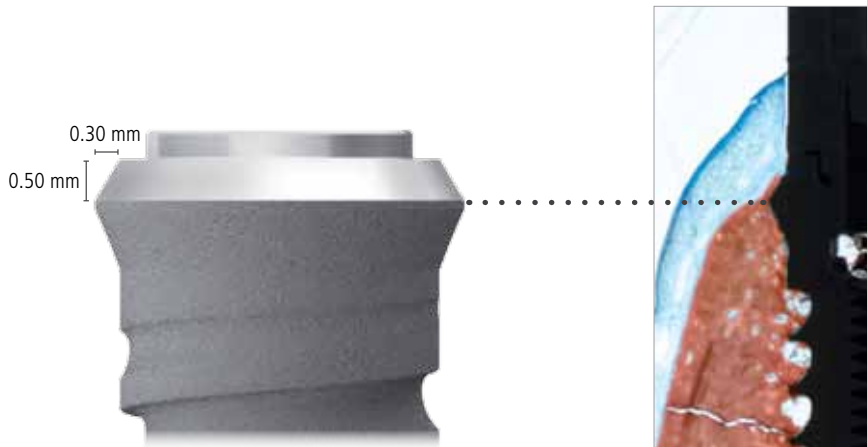

Ground Section of Premium Switching Platform implant 4 months after insertion.  
*(Image by kind permission of Dr D. Botticelli)*

## Maximising of soft tissues

The decision to simplify the range of Conoweld posts to two sizes is also supported by the excellent clinical results of the **Switching Platform protocols** reported in the literature.

With the Premium Kohno system, the Conoweld posts that rest on the COLLEX collar result in mismatching being available for a larger amount of gingival tissue, which is organised and stabilised in keratinised tissue around the prosthetic crown.

In addition, the implant-abutment joint is shifted not only horizontally but also vertically, maximising the distance from the soft tissues.

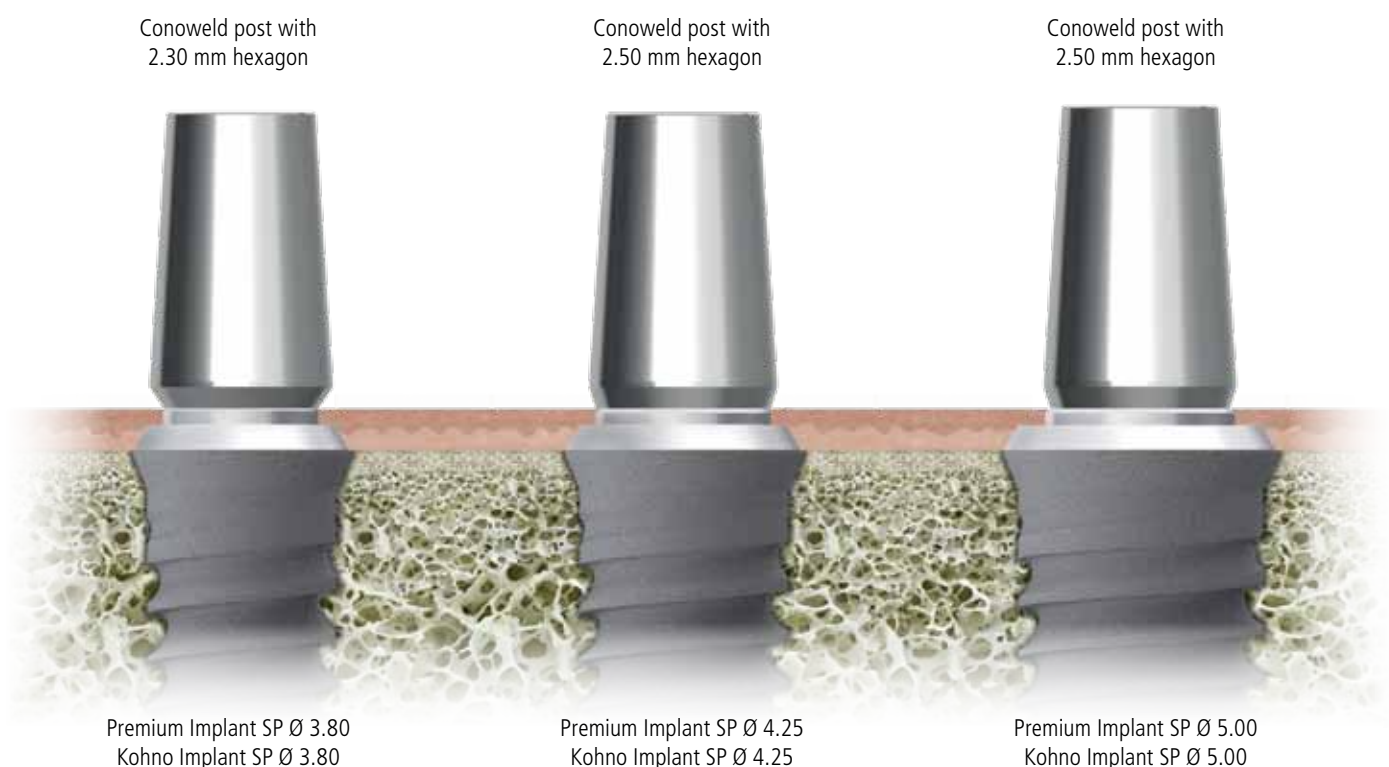



## Conoweld conometric technique

The Conoweld technique embraces the advantages of two protocols already widely established in oral implantoprosthesis: intraoral welding and conometric retention.

### Intraoral welding for the temporary stage

- stabilizes immediate loaded implants
- provides an immediate temporary prosthesis that is reinforced
- makes it possible to take a precise impression

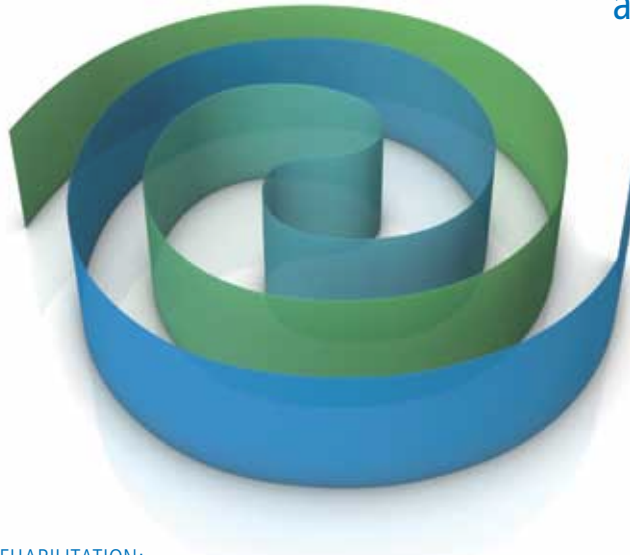

### Conometry for the temporary and final restoration

- cement-free restoration
- removable, but only by the dentist
- low-maintenance for the patient at home

#### ADVANTAGES OF CONOMETRIC REHABILITATION:

- Extremely reliable hold: the connection between the prefabricated conical cap incorporated in the over-structure and the post offers total mechanical stability that can be relied upon.
- Fully reversible: the dentist can remove the prosthesis at any time applying the same degree of force. Impossible for the prosthesis to move spontaneously: the consequent splinting of the implants makes it immediate loading possible and secure.
- Extremely simple to use: the posts are standardised and all fit the same caps.
- Low-maintenance for the patient, who has all the comfort of a fixed prosthesis, and easy to access for the dental hygienist.
- Natural passivation of the posts.
- Primary stability ensured with intraoral welding.

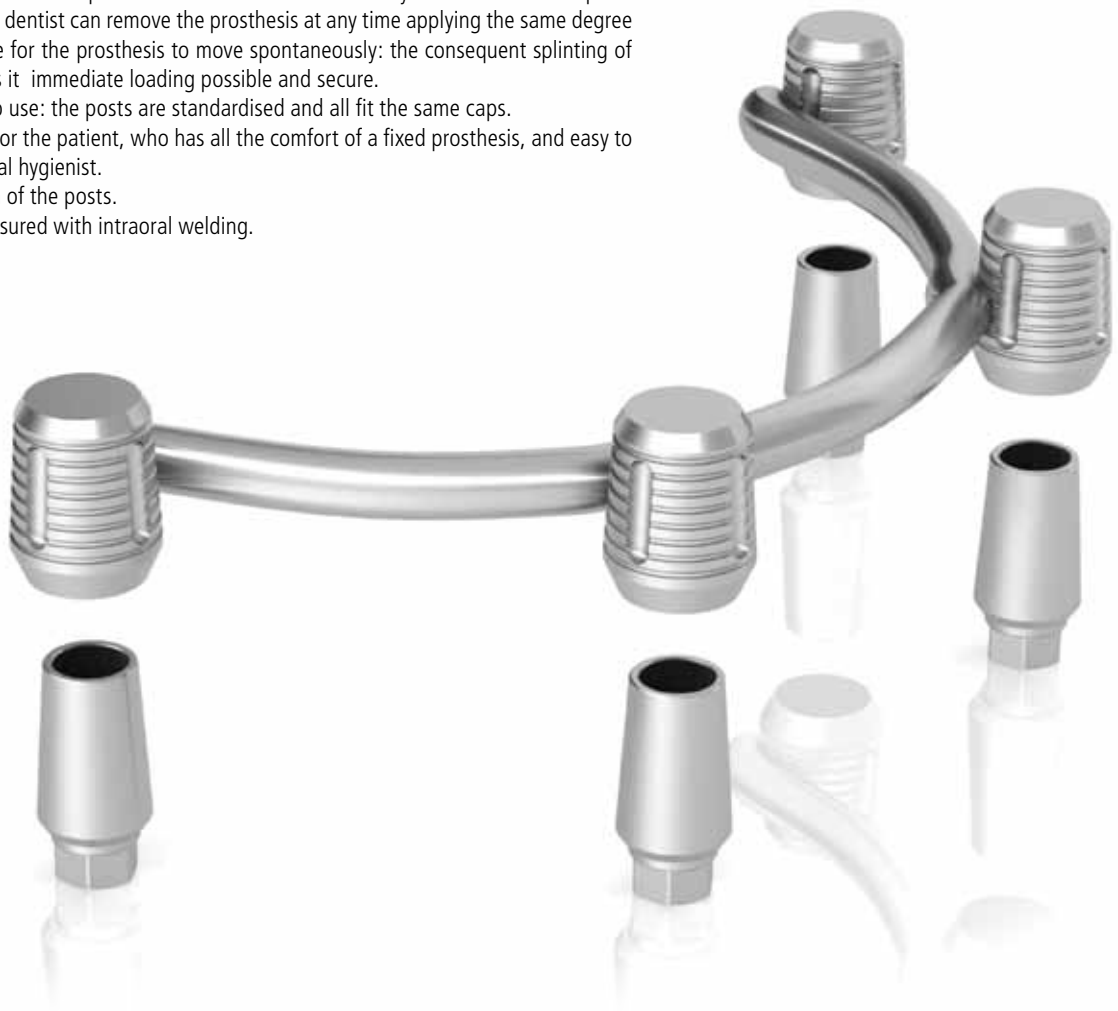





The technique involving the intraoral welding of the temporary caps in titanium is carried out by using equipment specifically designed for the purpose and which melt two pieces of titanium together, with a high intensity electric charge being passed through the point of contact, but for such a short time (a few milliseconds) that the surrounding tissues are not heated at all.

The **cap for the temporary stage** is welded to a titanium bar in order to create a structure that is solid but can be removed without having to unscrew the posts. In addition, being passivated in the mouth, this can operate as a reliable control key for accurately transferring an impression to the laboratory.

The **Conoweld post** can operate as a temporary as well as a permanent solution. Here it has the advantage of eliminating the biological stress linked to screwing, unscrewing and replacing the prosthetic components, protecting the intimate bond that is created between the mucous tissues and the emergence of the post.

This system, currently available for Premium Kohno and Shelta implants of all diameters, includes **posts with a conical body** that are straight as well as at 5°, 10° and 15° angles, to be used together with the special titanium caps for intraoral welding, at the temporary stage, and together with the corresponding permanent caps, to achieve rehabilitation with conometric retention both partial and full arch.



The **final cap** works on the same operating principle as the temporary cap; not needing to be of a thickness that is sufficient for the intraoral welding, it takes up far less space, making it easy to position in the prosthetic.

Completing the range is a handy **cap in PMMA**, which can be used for a snap-on impression as well as for casting, and a laboratory analog that can be easily repositioned not only on the impression but also on the fixed structure.

# Conoweld prosthetics for Premium, Kohno and Shelta implants

### Conoweld conical posts

The grade 5 titanium posts that form part of the Conoweld prosthetic range have been specifically designed to rest securely on the COLLEX collar. This makes it possible to have only two posts for the Premium and Kohno platforms: one with a hexagon with a 2.30 mm key for platforms with implant diameters of 3.30 mm and 3.80 mm, and one with a hexagon with a 2.50 mm key for platforms with implant diameters of 4.25 mm, 5.00 mm and 6.00 mm, without any difference between straight and SP implant emergences. The Shelta implants, which share the same connection with a hexagon with a 2.30 key, use the same Conoweld post.

#### POSTS WITH A 2.30 MM HEXAGON

The same Conoweld straight and angled posts with a 2.30 mm hexagon are used on Premium Kohno implants with  $\varnothing$  3.30 and 3.80 mm and on all diameters of Shelta implants, that is 3.80, 4.25 and 5.00 mm.



Premium  $\varnothing$  3.30



Premium  $\varnothing$  3.80  
Kohno  $\varnothing$  3.80



Shelta  $\varnothing$  3.80



Shelta  $\varnothing$  4.25



Shelta  $\varnothing$  5.00

#### POSTS WITH A 2.50 MM HEXAGON

The same Conoweld straight and angled posts with a 2.50 mm hexagon are used on Premium Kohno implants with  $\varnothing$  4.25 and 5.00 mm and for the Kohno implant  $\varnothing$  6.00 mm.



Premium  $\varnothing$  4.25  
Kohno  $\varnothing$  4.25



Premium  $\varnothing$  5.00  
Kohno  $\varnothing$  5.00



Kohno  $\varnothing$  6.00



2.30 mm



2.50 mm

Premium Kohno Ø 3.30 - 3.80 mm

Premium Kohno Ø 4.25 - 5.00 - 6.00 mm

Shelta Ø 3.80 - 4.25 - 5.00 mm

Conoweld post in grade 5 titanium,  
straight, transgingival height 0.50 mm.  
Connecting screw included

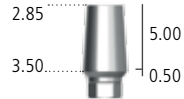

A-MD-TS-EX230-05

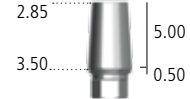

A-MD-TS-EX250-05

Conoweld post in grade 5 titanium,  
straight, transgingival height 1.00 mm.  
Connecting screw included

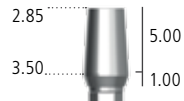

A-MD-TS-EX230-1

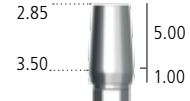

A-MD-TS-EX250-1

Conoweld post in grade 5 titanium,  
straight, transgingival height 2.00 mm.  
Connecting screw included

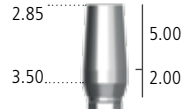

A-MD-TS-EX230-2

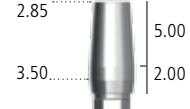

A-MD-TS-EX250-2

Conoweld post in grade 5 titanium,  
straight, transgingival height 3.00 mm.  
Connecting screw included

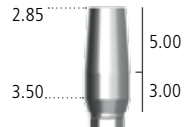

A-MD-TS-EX230-3

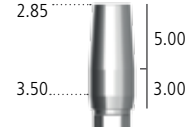

A-MD-TS-EX250-3

Conoweld post in grade 5 titanium,  
straight, transgingival height 5.00 mm.  
Connecting screw included

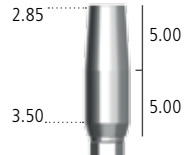

A-MD-TS-EX230-5

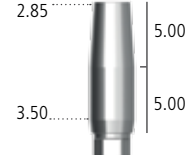

A-MD-TS-EX250-5

Conoweld post in grade 5 titanium,  
angled at 5°  
Connecting screw included

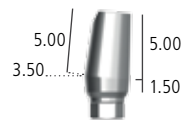

A-MA05-TS-EX230

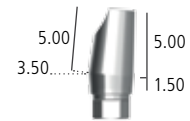

A-MA05-TS-EX250

Conoweld post in grade 5 titanium,  
angled at 10°  
Connecting screw included

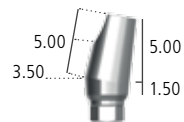

A-MA10-TS-EX230

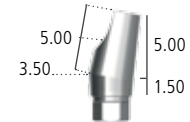

A-MA10-TS-EX250

Conoweld post in grade 5 titanium,  
angled at 15°  
Connecting screw included

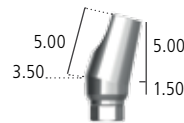

A-MA15-TS-EX230

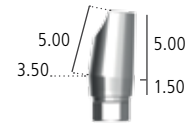

A-MA15-TS-EX250

Spare screws  
In packages of 10



VM2-180  
VM2-180-10



VM2-200  
VM2-200-10

Recommended tightening torque: 20-25 Ncm.

All measurements in mm, save where otherwise indicated.

# Conoweld conometric caps

The Conoweld range includes three different caps, which are universal in relation to the diameters of the posts and the implant platforms: this is due to the fact that conometric retention is in the most coronal portion of the post, which always has the same dimensions.

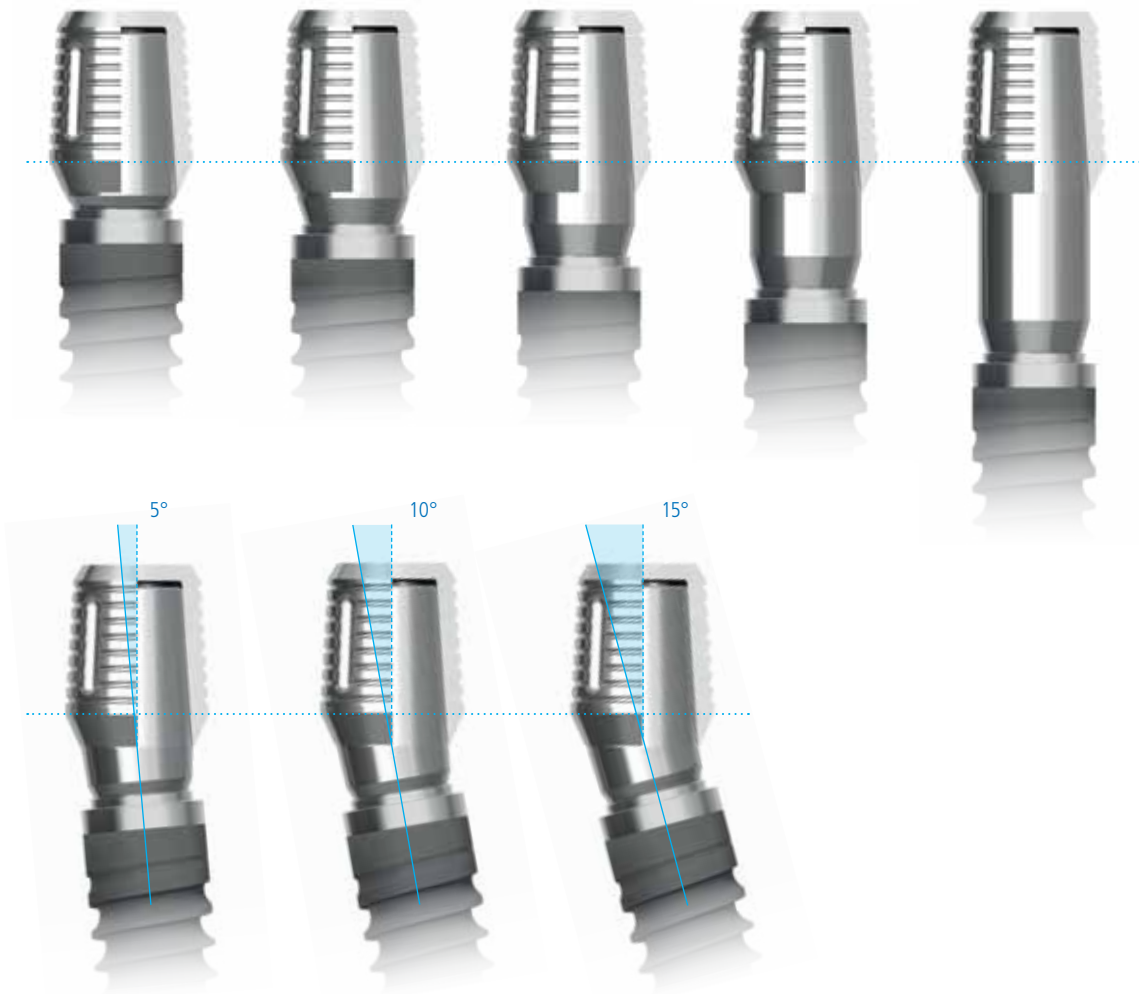

The two titanium caps differ in thickness: the cap designed for the construction of a welded structure intraorally for the temporary stage is thicker in order to withstand the welding with the titanium bars, without bonding with the underlying post, while the cap designed to anchor the final prosthesis glued on is thinner, in order to reduce the impact on the anatomical morphology of the prosthesis; it should not, therefore, be used for the welding.

A cap in PMMA is also available, which allows a precise impression to be taken even when working without an intraoral welding machine and which can be used for modelling and casting a structure entirely in cobalt chrome or other alloys, when the decision has been taken not to use gluing techniques for assembly.





code

description



5.70

Temporary cap for intraoral welding

CAP-TS-PRO



5.70

Final cap for gluing

CAP-TS-DEF



5.70

Cap for impression

CAP-TS-IMP



17.00

Analog of the Conoweld post

ANA-TS

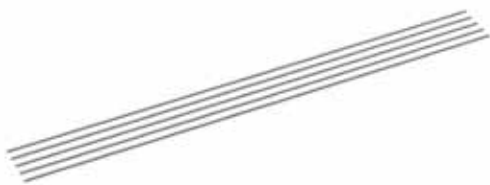

Bar in grade 2 titanium, L. 150 mm, Ø 1.20 mm, package of 5

DW-BARRA1.2

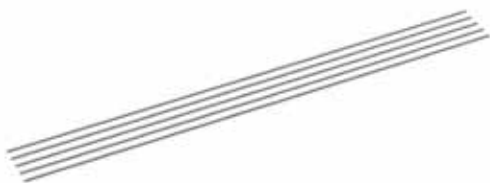

Bar in grade 2 titanium, L. 150 mm, Ø 1.50 mm, package of 5

DW-BARRA1.5

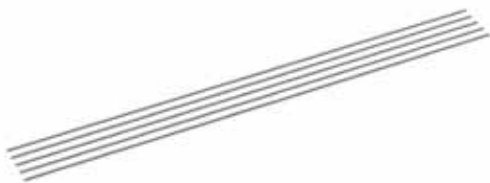

Bar in grade 2 titanium, L. 150 mm, Ø 1.80 mm, package of 5

DW-BARRA1.8

## DENT WELD

### Endoral welding machine

DENT WELD is a high-tech endoral welding machine for fixing implants in the event of immediate loading and to maintain maximum stability throughout the entire process of rehabilitation up until osseointegration of the implants. Welding is carried out by means of a high intensity electric charge being passed through the point of contact between two pieces of titanium, but for such a short time (a few milliseconds) that the surrounding tissues are not heated at all.



#### General features

- Dent-weld is the endoral welding machine with 100% Italian technology and quality, and is a medical device manufactured by Swiss & Wegman S.r.l., via Svezia 8, 35020 - Ponte San Nicolò (PD) ITALY and distributed in Italy exclusively by Sweden & Martina S.p.A..
- Safe and accurate, the welding machine is fitted with a microprocessor that guarantees complete safety in all applications.
- The practical titanium bars (which come in various diameters) to weld to the posts mean that implants can be fixed in the space of only a few seconds, with their stability being assured throughout the entire period of osseointegration.
- DENT WELD does not create sparks, it does not generate any risk for the patient because the forceps are automatically disconnected from the power supply during the welding phase.
- The heat produced is dispersed through copper electrodes, which have greater thermal conductivity than titanium, without causing any discomfort to the patient or to the doctor.
- DENT WELD also welds in the presence of saliva or any liquid.
- The pre-set programs make it easy to use.
- The forceps are easy to handle; fitted with a simple attachment, they are easy to sterilise.

#### Standard configuration

Control unit, forceps, cable, pedal, power cable, instruction leaflet.

#### Technical features:

Supply voltage:	230V AC
Frequency:	50 Hz
Average power absorbed:	10W
Weight:	7 kg
Dimensions:	33x22x17 cm
Classification:	I- BF, IPXO



See the instruction manuals for the equipment and the electrode forceps:



## Preliminary instructions for welding

### 1. Coupling stage

The coupling stage involves bringing the two materials into direct contact with one another, avoiding any stress. The pressure applied by the tips must bring the two shapes of the objects to be welded together so that they match perfectly, with absolutely no space between the two materials.

### 2. Welding stage

It is extremely important at this stage that pressure is maintained in order to keep the joints coupled, to act on contact resistance and to concentrate maximum resistance at the centre. It is recommended at this stage not to apply any force that resists the action of the pre-load spring in the forceps.







### 3. Cooling stage

Having completed the welding, pressure must be maintained for a few seconds (around five) in order to allow the heat that has been generated to dissipate via the electrodes



# Drivers

Connecting screws for all Conoweld posts can be screwed using the following drivers, included within all surgical and prosthetic kits for Sweden & Martina implants. They can also be ordered separately as spare parts.

code	description
 HSMXS-20-DG	Driver for tap screws and connecting screws, digital, extra-short
 HSM-20-DG	Driver for tap screws and connecting screws, digital, short
 HSML-20-DG	Driver for tap screws and connecting screws, digital, long
 HSM-20-EX	Driver for connecting screws, with connector for dynamometric ratchet or digital connector, short
 HSML-20-EX	Driver for connecting screws, with connector for dynamometric ratchet or digital connector, long
 HSMXL-20-EX	Driver for connecting screws, with connector for dynamometric ratchet or digital connector, extra long
 HSM-20-CA	Driver for connecting screws, with right angle shank



## Dynamometric ratchet CRI5

The surgical kit of the implant system contains a special ratchet (CRI5), with its own adjustment key, for quickly screwing the torque adjustment ring nut, and with gel lubricant for maintenance. The ratchet may be used with torque adjustment from 10 to 70 Ncm or in a blocked position without torque control. When using as a prosthetic ratchet for fastening the screws, refer to the torque values given in the table on the previous page. The ratchet key CRI5 is a multi-purpose instrument that can be disassembled, and is sold unsterile. It is included in the Screw Kit and in all surgical kits of Sweden & Martina Implant Systems. It is also available as a replacement.



### IMPORTANT WARNING

All components that are to be tightened at a torque of less than 10 Ncm must be tightened by hand.  
For example: Transfer screws to be tightened at 8 Ncm.

Before each use, this instrument must be cleaned and sterilised according to the instructions on pages 38-39. Adequate maintenance, performed following in detail all the step by step instructions for the disassembly and correct reassembly of the device during cleaning operations, is essential for the correct functioning of the device and for its durability. Personnel who use this tool must be suitably trained, and they must have read the instructions in this manual prior to handling the device.

After sterilisation, the key is ready for use. A test to verify the correct assembly and functioning of the key is necessary before any surgical or prosthetic interventions.

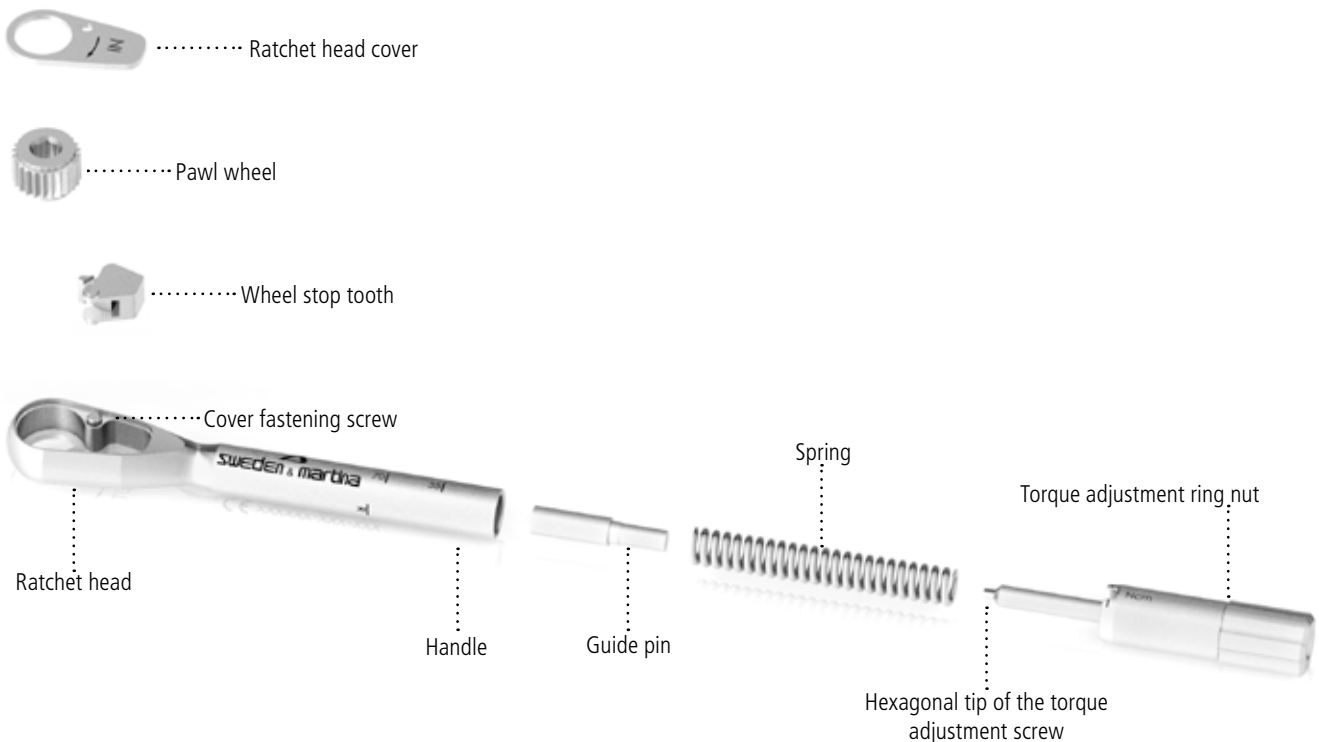



After sterilization the key is ready to use; before any surgical or prosthetic procedure a test to check the correct assembling and functioning of the key is mandatory.

The torque is adjusted by aligning the marking of the desired torque in the circular opening of the handle. The "IN" arrow legible on the top of the head indicates the screwing position of the key. The "OUT" arrow legible on the top of the head indicates the loosening or unscrewing position.

An unlimited torque position is obtained by positioning the torque adjustment device up to the line marked "R" on the handle of the ratchet body.



### IMPORTANT WARNING

The torque is adjusted by screwing/unscrewing the ring nut located at the bottom of the instrument's handle. The torque must always be adjusted on the rise, starting screwing from a lower value until the desired torque is reached, or unscrewing the ring nut in a clockwise direction. To do this, if it is necessary to set a torque lower than the last one used, you must unscrew the ring nut by two turns below the value of the desired new torque, and work up to that value by rescrewing the ring nut in a clockwise direction.

The ring nut may be screwed and unscrewed by hand, but to speed up these operations the kit also contains a driver that allows it to be turned quickly.

Any deterioration of the screwing, insertion and torque mechanisms must be checked by personnel responsible for the use and maintenance of this dental instrument.

The pieces of this mechanism are not interchangeable; one piece from one key cannot be replaced by a piece from another key as each ratchet is calibrated INDIVIDUALLY. If a piece is lost, please return the instrument to Sweden & Martina for repair. No components for assembling the ratchet can be sold individually.

Failure to follow the instructions provided may cause problems of maintenance and stability of the prosthesis.

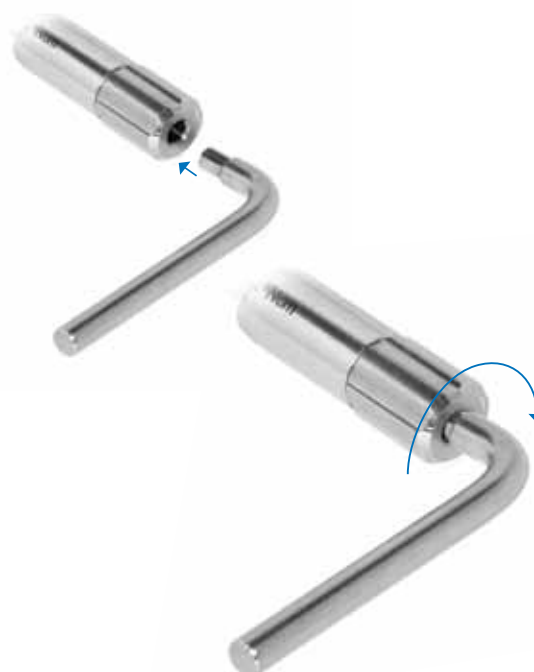

# Fixing stage - endoral welding on Conoweld caps for immediate loading

Position the Conoweld posts on the implants, accurately assessing the transgingival height that is the most suitable and the angle that is most appropriate in the case of disparallel implants. Tighten the connecting screws using one of the HSM drivers (see page 15 for lengths and types available) at a torque of no more than 25-30 Ncm.

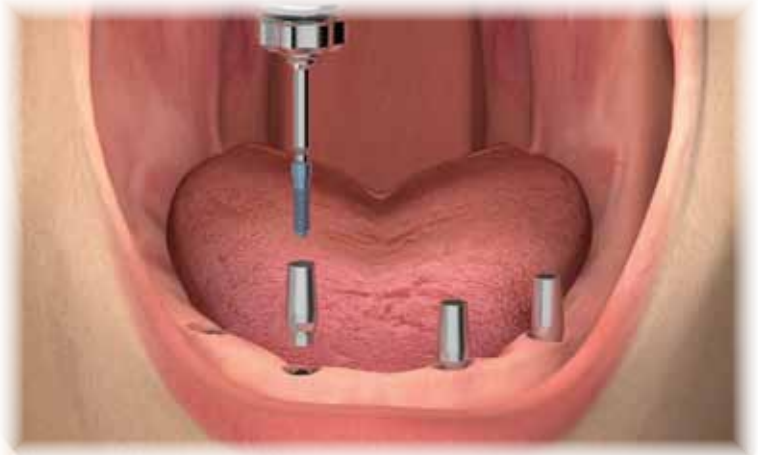

Position the temporary Conoweld caps on the abutments, gently applying manual pressure. Take a titanium bar for intraoral welding of the most suitable thickness and curve it manually in line with the arch to be rehabilitated.

**Note:** avoid cutting the bar to measure at the outset, as the excess segment makes removal and repositioning easier to handle until the welding of the caps is complete.

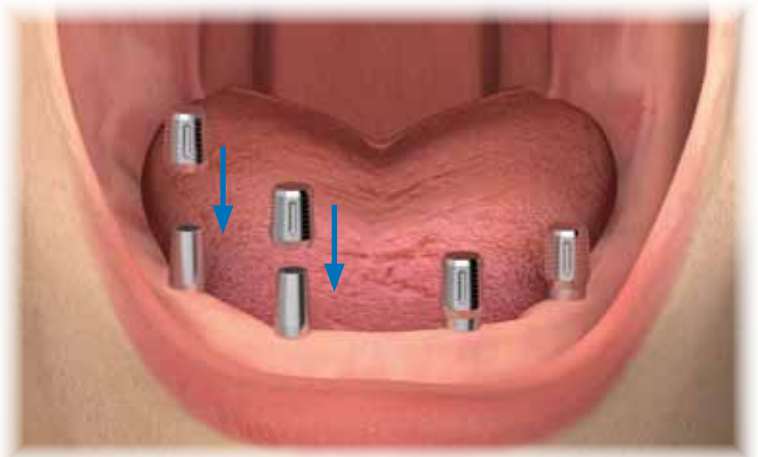

Line up the first segment of the bar with one of the two distal caps and carry out welding with the special intraoral welding machine, following the manufacturer's instructions.

### IMPORTANT WARNING

To set the operating parameters for the welding machine and for the relevant information and warnings, read and follow the instructions in the manual issued by the manufacturer of the equipment.

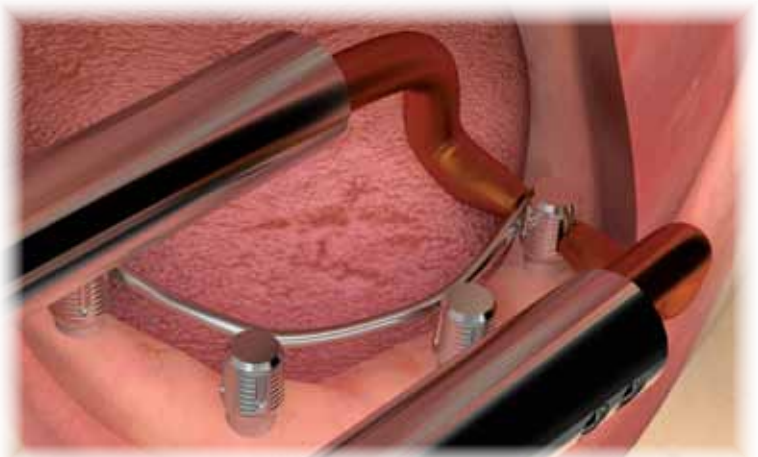



In order to establish that the procedure has been carried out correctly, it is advisable to remove the bar and caps that have been fixed up until that point after each welding and before the next. This helps to establish that the wall of the cap and the underlying post have not bonded and to be sure that a passive structure is being built.

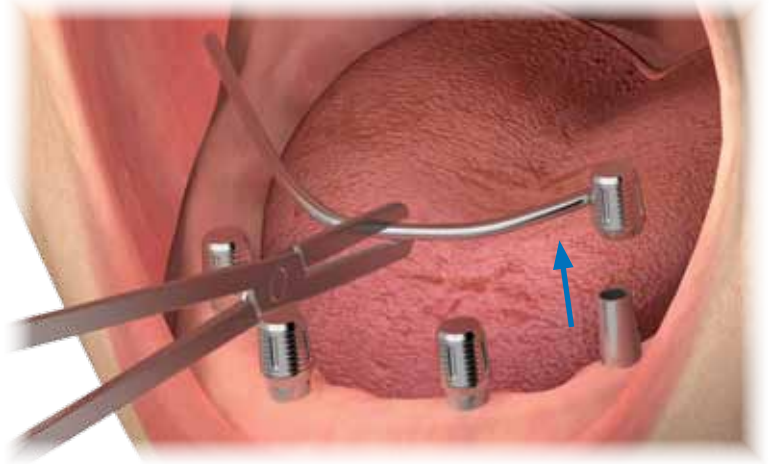

Having positioned the first cap back on its post, guide the bar round and, if necessary, remodel it, in order to weld it to the next cap along.

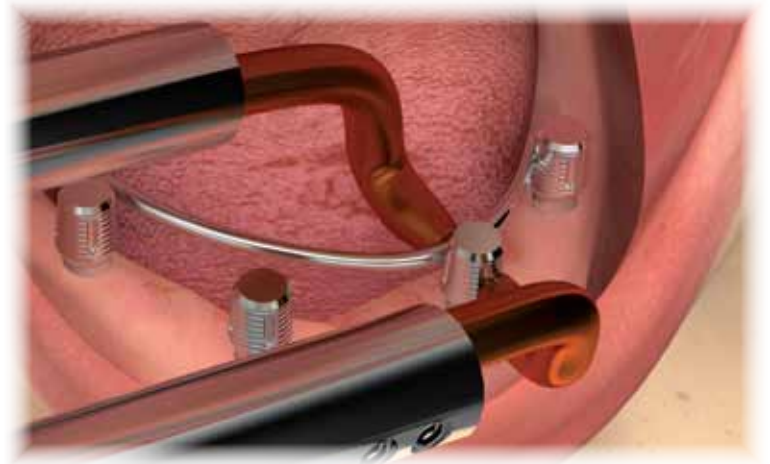

Remove the structure made up of the bar and the first two caps welded to it in order to establish that that the wall of this second cap and the underlying post have not bonded and to establish that the structure is passive.

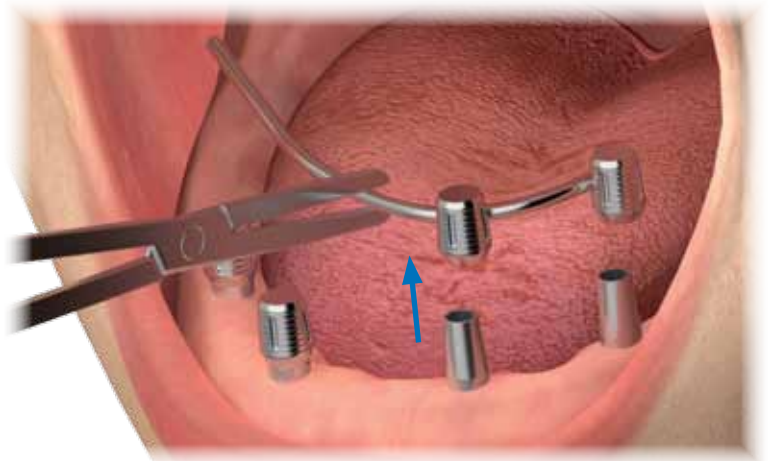



## USE PROTOCOLS

---

Having positioned the first and second caps back on their posts, guide the bar round and, if necessary, remodel it, in order to weld it to the next cap along.

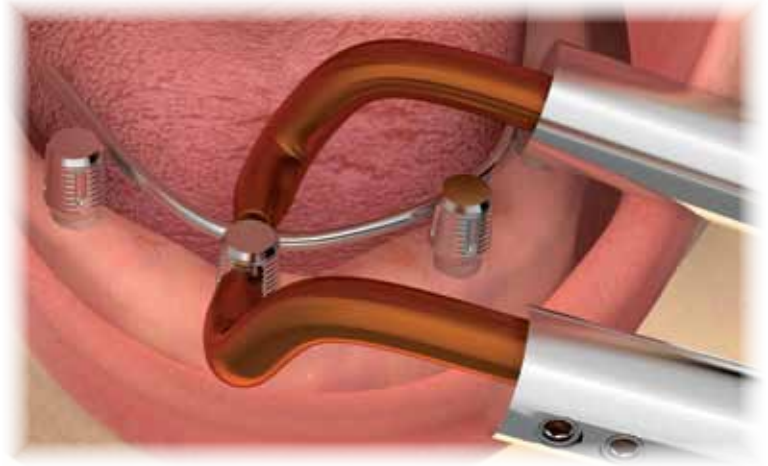

Remove the structure made up of the bar and the three caps welded to it in order to establish that there is no casting between the wall of this third cap and the underlying post and to establish that the structure is passive.

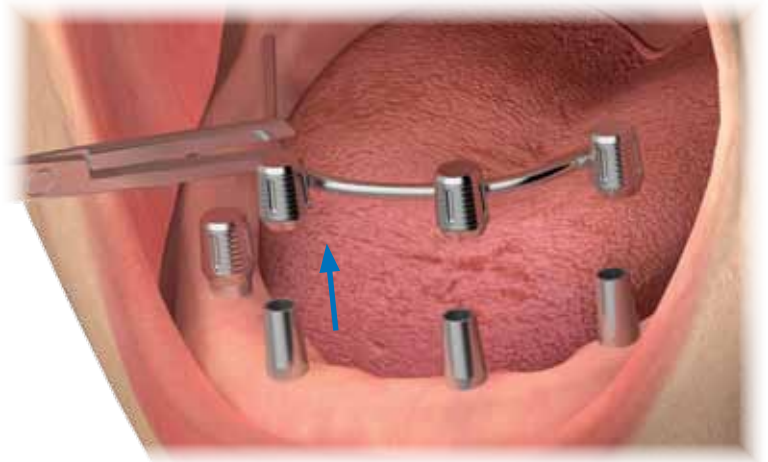

Having positioned the three caps back on their posts, guide the bar round and, if necessary, remodel it, in order to weld it to the next cap along.

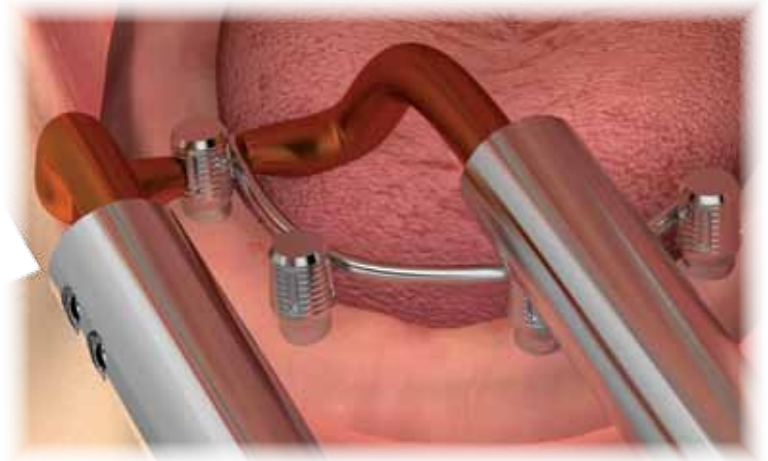



Remove the entire structure made up of the bar and the four caps welded to it in order to establish that that the wall of the last cap and the underlying post have not bonded and to establish that the structure is passive.

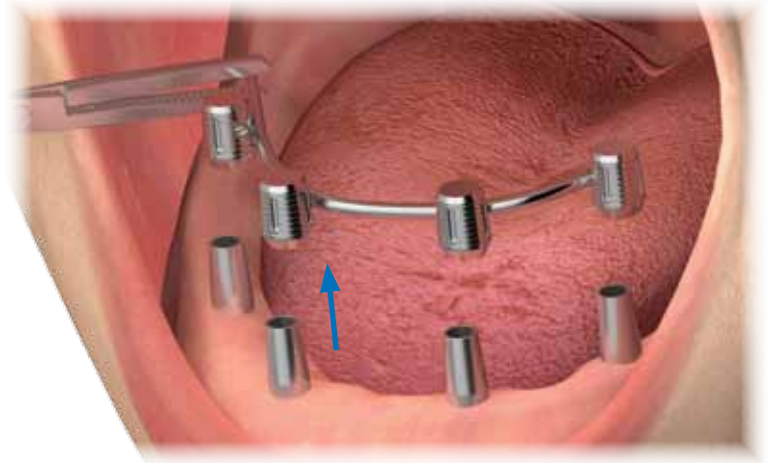

In order to further increase the passive nature of the structure and eliminate any residual stress, welding is advisable at a halfway point along each segment of free titanium along the bar.





A

If a more rigid structure is required or if titanium bars with a thin diameter are being used, an additional bar can be welded onto the caps, following the exact same procedure as for the first bar, i.e. one cap at a time, removing the structure after each welding. The preferable positioning is the 'gun barrel' style (A), i.e. two parallel bars, one sitting above the other. There are other solutions, however, such as crossed bars (B) and bars forming a rail (C) i.e. parallel horizontally. This type of structure is particularly useful where the caps descend 1.5 mm into the sulcus, leaving only 4 mm of wall available for welding. This arrangement is, however, only suggested in the distal sectors, where problems are not usually encountered with thickness. Whilst the additional bar should not be capable of generating traction, here too the free segments can be passivated with a welding point. Where the bars are positioned to form a rail, welding is carried out by inclining the forceps vertically in order that only one segment is gripped between the two electrodes.



B

**Note:** whilst it is advisable for both bars to have the same thickness (usually two bars of 1.50 mm), different diameters can also be used.

### IMPORTANT WARNING

Do not attempt to passivate both segments at the same time. As the welded structure would in any event close the circuit, the bars would soften and deform under the pressure of the forceps, creating additional stress and weakening the structure instead of passivating it.



C





## Creation of the temporary prosthesis: direct protocol



The temporary prosthesis for immediate loading can be made in the laboratory or chair-side, relining a ready-made moulded prosthesis. The resin will incorporate the welded structure entirely, which also makes it easier for the patient to clean it at home.



Once the base of the temporary prosthesis has been smoothed, it can be positioned onto the Conoweld posts immediately: the interaction via conometry between the posts and the Conoweld caps will mean that, in terms of retention, the dentist will be able to remove the temporary prosthesis at any time, but the patient will not be able to remove it themselves. This particular feature of conometric rehabilitation ensures solid splinting throughout the entire osseointegration period, limiting the micromovements of the implants, even where the bone is only slightly mineralised.



### Indirect protocol: impression on the welded structure

The structure including the temporary Conoweld caps welded onto the titanium bars forms an accurate and reliable impression key. The impression can therefore be taken incorporating the entire structure within the material inside the tray. As the caps rub against the posts as a result of conometry, it is advisable to use hard impression material for edentulism (e.g. SKY IMPLANT ONEMIX- ED, code SKY08).

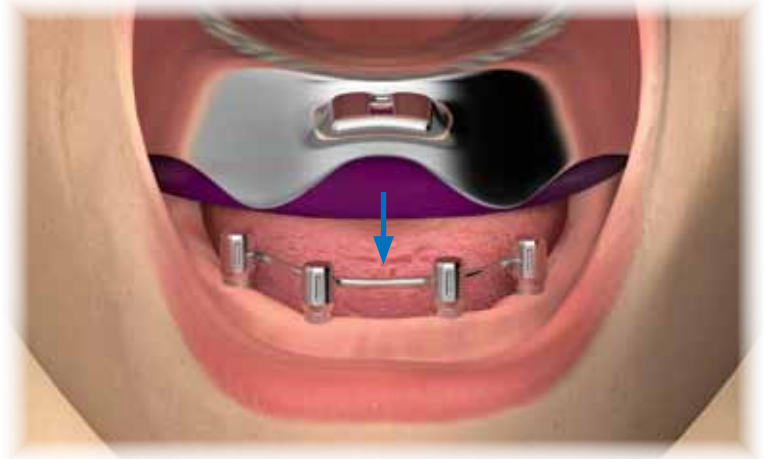

Push the impression tray onto the welded structure so that, despite its fairly rigid consistency, the impression material incorporates the bar and the caps welded onto it completely.

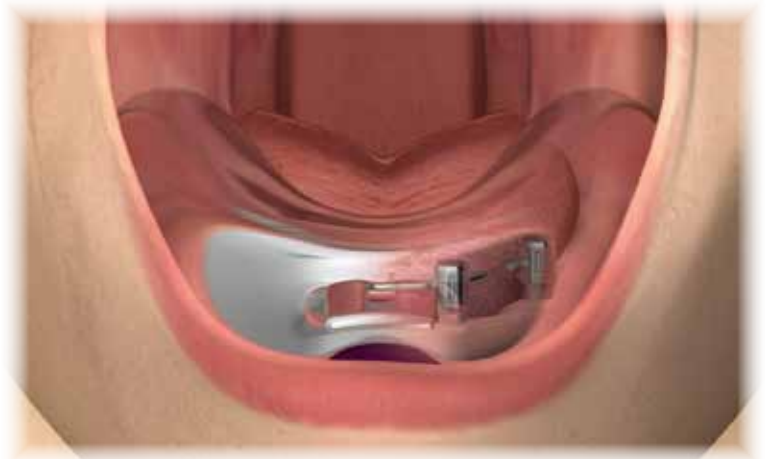

Lift the tray vertically: the entire welded structure will remain incorporated in the impression material.

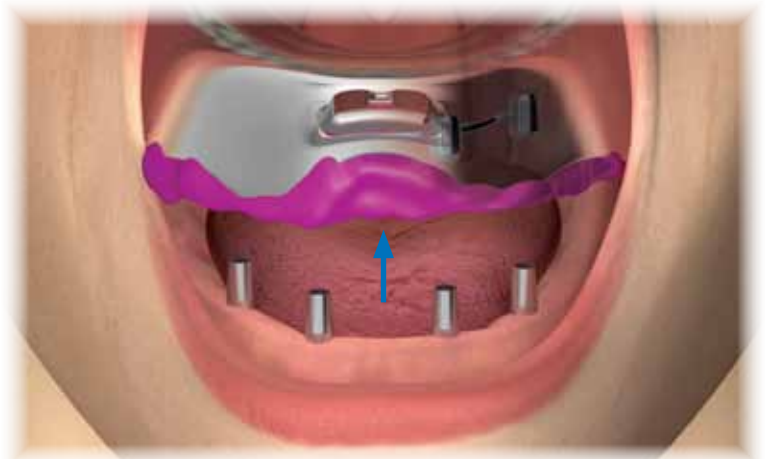



One by one, reposition the analogs in the metallic caps. Send the impression to the laboratory. Cast the model in the usual way.



Release the structure from the impression material, taking care not to create distortions, and position it on the model in order to check that it is completely passive.



On the structure, build a temporary prosthesis in resin, and then return to the patient in order to position this in the mouth.



### Indirect protocol: impression with Conoweld transfer caps in PMMA

As an alternative, the impression can be taken using the special Conoweld caps in PMMA, inserting them on the Conoweld posts and gently applying manual pressure. Fix the caps between each other using resin and wire, if desired.

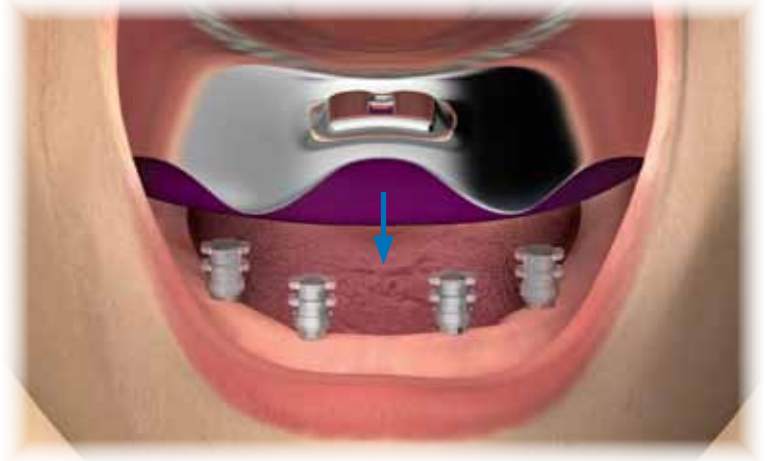

Take a closed tray impression, ensuring that, vertically, the caps and posts are included in the impression material in their entirety. Leave to harden for the amount of time indicated by the manufacturer.

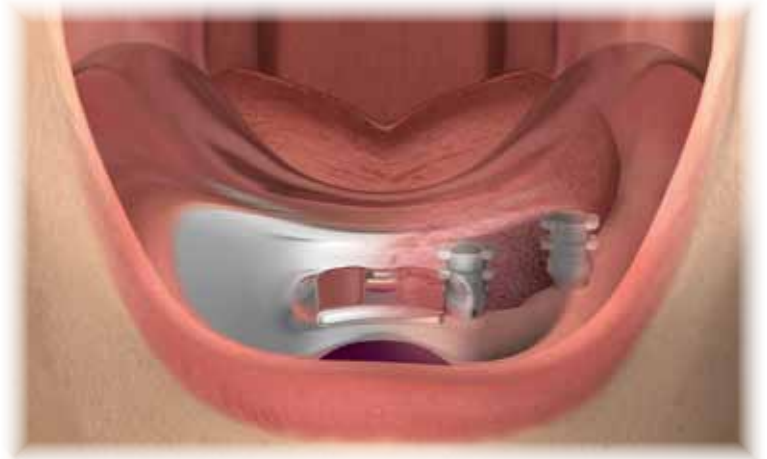

Lift the impression tray: the PMMA caps will remain securely incorporated in the hardened material.

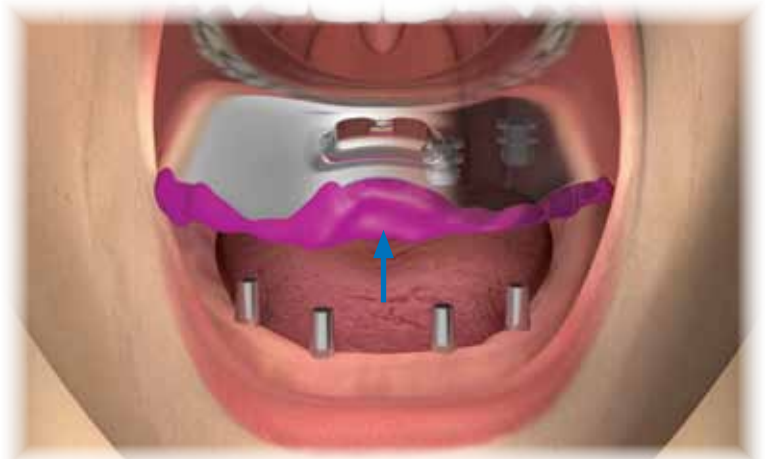



Reposition the Conoweld analogs in the caps, now incorporated into the impression material, and send the impression to the laboratory together with the intraorally welded structure. Cast the model in the usual way.

### IMPORTANT WARNING

As the emerging portion of all of the posts is equal, there is one analog only (code ANA-TS) for all the straight and angled posts of any diameter.



The resulting model can be used to build over it a reinforcement for the temporary prosthesis, which is welded in the laboratory or obtained via traditional techniques using the locker taping components of the system. Test the passivity of the structure on the model, whether created intraorally or in the laboratory.



On the structure, build a temporary prosthesis in resin, and then return to the patient in order to position this in the mouth.





# Creation of final conometric prosthesis

## Technique for gluing cast structure onto titanium caps

Take a precise impression in accordance with the protocol set out on pages 26-27. Position the final titanium caps on the posts, gently applying manual pressure.

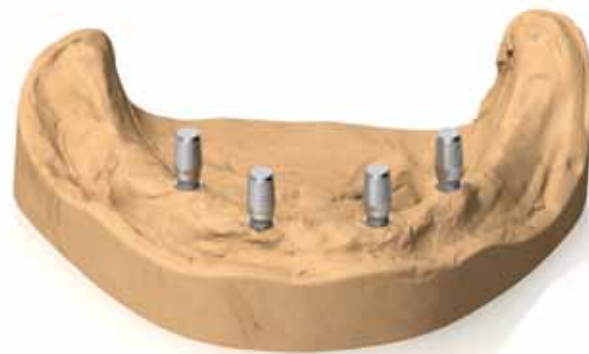

Wax the structures, interposing a lab spacer in order to passivate the final prosthesis and facilitate the gluing of the caps that is to follow.

The caps will only be in direct contact with the structure on the flat occlusal surface, making a precise reset of the structure possible on the model in the laboratory as well as during the various intraoral tests.



Cast only the structure made in wax, leaving the Conoweld caps on the model.

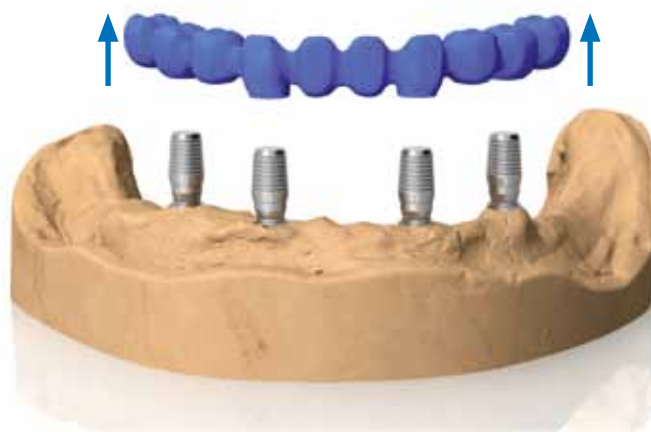



Smooth the base of the structure and complete the coating in ceramic.



Then glue the caps onto the base of the cast structure, each one being housed within one of the respective spaces. It can help here to spread small layer of primer before cementing.

### IMPORTANT WARNING

To obtain the best results in terms of precision and passivity, we advise that the caps be glued intraorally. Gluing cannot be carried out before ceramic is applied, as the temperatures used in firing the ceramic are incompatible with all cement types.





# Creation of final conometric prosthesis

## Technique for complete casting with castable caps

Position the Conoweld caps in PMMA on the Conoweld plaster analogs, gently applying manual pressure.

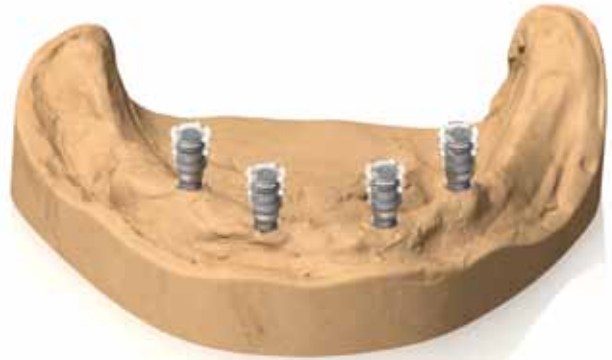

If necessary, reduce the castable caps appropriately to fit within the silicone mask or with the spaces defined by the articulator.



Complete a wax-up of the final structure that incorporates the Conoweld castable caps.





Cast the structure made in wax that has the Conoweld castable caps inside it.



Finish the base of the structure and complete the coating in ceramic.

### **IMPORTANT WARNING**

Structures produced by bonding the castable caps may require a minimal quantity of cement in order to be fixed intraorally: given its own limitations, casting makes it difficult to achieve the same fit as with the standard caps for gluing.



# Case report: bridge on two elements using the Conoweld technique

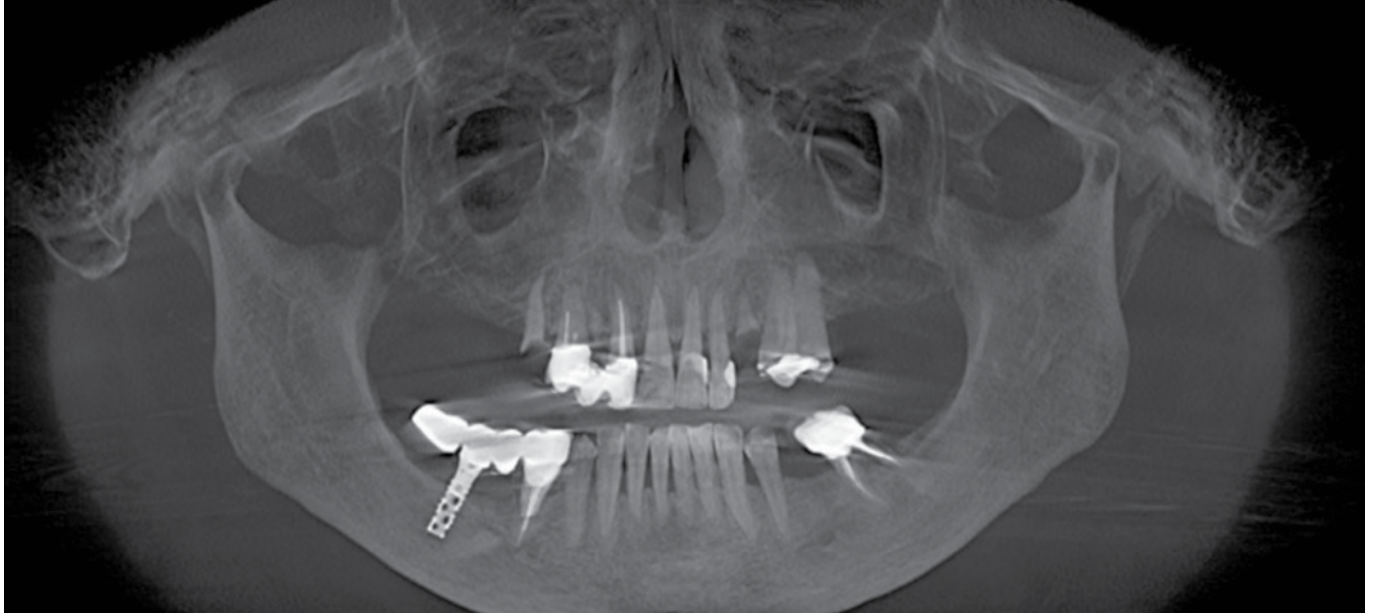

Upon examination, we found that the patient required rehabilitation of the 3<sup>rd</sup> quadrant in region 35 and 36 following the avulsion of the severely damaged element 36. At the patient's request, the implants were not positioned immediately following extraction, the decision being taken to delay positioning.



Four months after extraction, using the flapless technique, two Shelta (Sweden & Martina) implants were positioned, being respectively 3.80 mm in diameter and 11.5 in length in region 35 and 4.25 mm in diameter and 11.5 in length in region 36. An insertion torque of 65 Ncm was applied.



Two final conical posts of reduced diameter for use with the Conoweld conometric system were positioned on the implants.



In the same surgical phase, the Conoweld preformed conometric caps were positioned.



The caps are fixed with intra oral welding (DENT WELD, distributed by Sweden & Martina) using a titanium bar with a 1.5 mm diameter. The result is an extremely precise prosthetic, that is removable, which means that a temporary prosthesis can be made for immediate loading.



The welded caps are removed in order to check for passivity and to see whether they can be incorporated into the prefabricated temporary prosthesis.

Once the electro-welded structure has been repositioned on the posts, direct relining is carried out on the temporary prosthesis in order to incorporate this structure and, therefore, obtain a reinforced removable prosthesis that will also have the advantage of fixing the implants.



Removal of the relined temporary prosthesis, which will then be finished and polished.

Application of the temporary prosthesis without cement, exploiting the properties of the morse cone

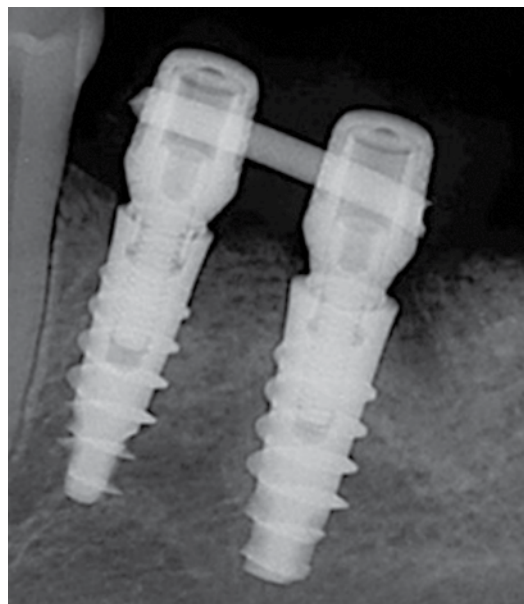
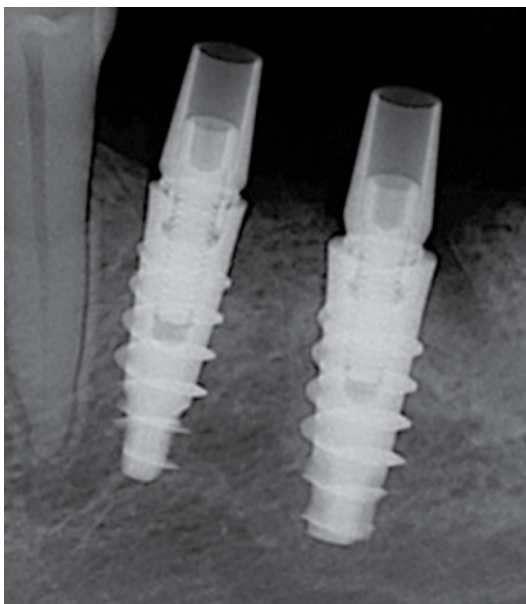

X-rays which highlight the precision of the components and the switching platform achieved with this type of post (Sweden & Martina).

## Conclusions

This case report shows how, using this technique, a prosthesis for immediate loading can be made that complies with the concepts of platform switching, positioning, as early as the surgical stage, the final post that will now remain in place, given the availability of posts with various transgingival heights. Use of the conometric caps built in advance means that a high level of precision can be obtained, with fixing via electro welding making it possible to stabilize the positioned implants and, chair-side, to make a temporary prosthesis which, as well as being extremely resistant, can easily be removed by the dentist at any time.

The fact that this method is standardized and can be adapted to suit the various Sweden & Martina implant systems makes it easy to use and cost-effective.

# GENERAL INDICATIONS

GRADE 2 TITANIUM*	Maximum allowed values (%)	Tolerance
<b>Chemical composition:</b>		
Nitrogen	0.03	+/- 0.02
Carbon	0.08	+/- 0.02
Hydrogen	0.015	+/- 0.002
Iron	0.30	+/- 0.10 (%<0.25) +/- 0.15 (%>0.25)
Oxygen	0.25	+/- 0.02 (%<0.20) +/- 0.03 (%>0.20)
Titanium	remainder	-

Mechanical properties*	
Tensile stress:	500 MPa (N/mm <sup>2</sup> )
Yield strength (0.2%):	275 MPa (N/mm <sup>2</sup> )
Elongation at yield:	20 %
Section reduction:	30 %

\* This technical information complies with the express specifications of the regulations in force for the use of grade 2 titanium in implantology.

GRADE 5 TITANIUM**	Maximum allowed values (%)	Tolerance
<b>Chemical composition:</b>		
Nitrogen	0.05	+/- 0.02
Carbon	0.08	+/- 0.02
Hydrogen	0.012	+/- 0.002
Iron	0.25	+/- 0.10
Oxygen	0.13	+/- 0.02
Aluminium	5.50÷6.50	+/- 0.40
Vanadium	3.50÷4.50	+/- 0.15
Titanium	remainder	-

Mechanical properties**	Maximum allowed values (%)
Tensile stress (for bar diameters up to 44.45 mm):	860 MPa (N/mm <sup>2</sup> )
Yield strength (0.2%):	795 MPa (N/mm <sup>2</sup> )
Elongation at yield:	10 %
Section reduction	25 %

\*\* This technical information complies with the express specifications of the regulations in force for the use of grade 5 titanium in implantology.

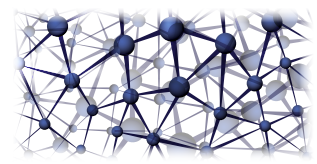

## PMMA

<b>Chemical designation:</b>	Polymethylmethacrylate
Colour:	Transparent
Physical and mechanical properties	
Density (DIN 53479):	1.18 g/cm <sup>3</sup>
Compressive yield strength (ISO 527, DIN 53454):	110 N/mm <sup>2</sup>
Elongation at Break (DIN 53455, ISO 527)	5.5 %
Flexural strength:	115 N/mm <sup>2</sup>
Modulus of elasticity (ISO 527, DIN 53457):	3300 N/mm <sup>2</sup>
Tangent modulus of elasticity at ca. Hz (DIN 53445)	1700 N/mm <sup>2</sup>
BRINELL HARDNESS BALL FALLING (DIN 53456)	200 N/mm <sup>2</sup>
<b>Thermal properties</b>	
Linear expansion coefficient for 0...50° (DIN VDE 0304/01):	70-10 · 1/°C
Thermal conductivity (DIN 52612):	0.19 W/m °C
Oven temperature	≈ 160 °C
Regaining temperature	>80 °C
Continuous max. exercise temperature:	78 °C
VICAT temperature proceeding B (DIN 53460):	115 °C
ISO 75 flection resistance 1.80 N/mm <sup>2</sup> (DIN 53461):	105 °C
Heat resistance according Martens (DIN 53458):	95 °C
<b>Various data</b>	
Water absorption in weight increase after 1 day immersion (DIN 53495):	0.3 %



# Clinical indications

The modern oral implantoprosthesis, with immediate or deferred loading, is a well-tested and reliable discipline able to solve virtually almost all edentulism problems, both functional and cosmetic. Restorations can replace a single tooth (implant-supported crown), a group of neighbouring teeth (implant-supported bridge) or an entire arch. This manual deals with the use of Conoweld components for making temporary prostheses for immediate loading and final prostheses of the conometric type.

Implant-prosthetic rehabilitation must meet certain fundamental criteria:

- the presence of a certain amount of bone;
- the primary stability of the implants after insertion;
- good periodontal (gingival) support;
- no bruxism (teeth grinding) or serious malocclusion;
- the presence of good occlusal balance (correct masticatory occlusal plane).

## Warnings and contraindications

When assessing the patient, in addition to his/her eligibility as regards implant-prosthetic rehabilitation, it is usually necessary to consider the contraindications that apply to dental surgery procedures in general.

These include:

- clotting disorders, anticoagulant therapy;
- healing or bone regeneration disorders;
- decompensated diabetes mellitus;
- metabolic or systemic diseases that compromise tissue regeneration with a particular influence on healing and bone regeneration;
- alcohol abuse, smoking and use of drugs;
- immunosuppressive therapy, such as chemotherapy and radiotherapy;
- infections and inflammations, such as periodontitis and gingivitis;
- poor oral hygiene;
- inadequate motivation;
- occlusion and/or articulation disorders as well as an inadequate interocclusal space;
- inadequate alveolar process.

It is contraindicated to insert implants and prostheses in patients with poor general or oral health, those who are unable to monitor their general conditions properly or those who have had organ transplants. Psychologically unstable patients and poorly motivated or uncooperative patients should also be considered unsuitable for this kind of treatment. Patients with poor periodontal health should first be treated and allowed to recover. In the presence of a lack of bone substance or poor quality of the receiving bone, such as to compromise the stability of the implant, suitable guided tissue regeneration must be performed prior to implant treatment. Contraindications also include: bruxism, allergy to titanium (extremely rare), acute or chronic infectious diseases, sub-acute chronic maxillary osteitis, systemic diseases, endocrine disorders, diseases resulting in microvascular disorders, pregnancy, breastfeeding, previous exposure to radiation, haemophilia, neutropenia, steroid use, diabetes mellitus, kidney failure and fibrous dysplasia. The normal contraindications common to all oral surgery must also be observed. Surgery is not recommended for patients on anti-coagulant, anti-convulsant and immunosuppressant therapies, with active inflammatory-infective processes of the oral cavity, and patients with BUN and creatinine values outside the norm. Patients with cardiovascular disease, hypertension, thyroid or parathyroid diseases, malignant tumours found in the 5 years preceding the operation, or nodular swellings must also be rejected. Chemotherapies reduce or eliminate the ability of osseointegration, therefore patients undergoing these treatments must be carefully screened before being rehabilitated with oral implantoprosthesis. Numerous cases of bisphosphonate-associated peri-implant osteonecrosis of the mandible have been reported in the literature. This problem particularly applies to patients treated intravenously.

Restoration work must always be planned in advance. Restoration planning must be performed in concert with the dental technician. The restoration-guided insertion of implants facilitates the prosthodontist's work and provides better guarantees in terms of duration. It is recommended to collect and file all the clinical, radiological and radiographic records.

Marked on each package are the code, a description of the content and the batch number. These same details, which are also indicated on the labels to be attached to the patient's records, must always be provided by the practitioner in any relevant correspondence. When handling the devices, both during use and during cleaning and sterilisation, practitioners should at all times use surgical gloves for personal protection against bacterial contamination. Failure to comply with these warnings may lead to cross-infection. The packaging conforms to European standards

## Identification of the manufacturer

The manufacturer of the prosthetic components and of the instruments described in this manual is:

### **Sweden & Martina**

Via Veneto 10

35020 Due Carrare (Padova) - Italy

Tel. +39 049.9124300 - Fax + 39 049.9124290

e-mail: [info@sweden-martina.com](mailto:info@sweden-martina.com) [www.sweden-martina.com](http://www.sweden-martina.com)



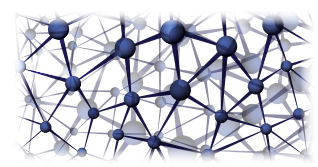

## Risk Classes

In accordance with Directive 93/42/EEC adopted in Italy with L.D. 46/97 of 26 March 1997, Annex IX, Sweden & Martina identifies the prosthetic components and the surgical instruments described in this manual as medical devices and identifies the risk class as shown in the following table. Even though they can be used in all patients who have the suitable therapeutic indications, all the devices listed must only be used by professional dentists or surgeons with the necessary qualifications and training and by dental technicians in the preparation of the prostheses.

Device	Classification	Packaging	Rule annex IX	Risk Class
Caps for taking impressions on posts	Short-term, invasive, surgical components	Disposable, non sterile	7	2A
Conoweld posts and the respective locker tapping caps, both temporary and final	Long-term, invasive, surgical components for use in the oral cavity.	Single use, non-sterile, complete with connecting screws.	8	2B
Connecting screws for posts	Long-term, surgical, invasive medical device accessories for use in the oral cavity.	Disposable, non sterile Sold together with the corresponding posts or individually, in single or multiple packages	5	2A
Titanium bars for intraoral welding	Long-term, invasive, surgical components for use in the oral cavity.	Disposable, non sterile	8	2B
Analogs of Conoweld posts	Non invasive medical device	Disposable, non sterile	1	1
Dynamometric ratchet	Reusable surgical instrument for temporary use (for less than 60 minutes at a time).	Reusable, non sterile	6	1
Right-angle driver	Invasive surgical instrument for temporary use (for less than 60 minutes at a time), intended to be connected to an active medical device.	Reusable, non sterile	6	2A
DRIVERS FOR RATCHET	Reusable invasive surgical instruments for temporary use (for less than 60 minutes at a time), not intended to be connected to an active medical device.	Reusable, non sterile	6	1

## Disposable devices

The prosthetic components are disposable. Disposable means that each individual device may be used just once, on a single patient. It is common practice for prosthetic components to be tried in the patient's mouth several times and then sent back to the dental technician for final restoration. This practice is valid and does not alter the concept of 'disposable', provided the same prosthetic component is always used by the same patient and him/her alone. In the case of multiple restorations, it is important that the same component is always used in the same position and connected to the same implant, i.e. that the components are not switched within the same rehabilitation.

Failure to comply with these indications may compromise the precision of the work. Any reuse in other patients must be considered off-label use and, in such cases, Sweden & Martina declines all responsibility.

# GENERAL INDICATIONS

## Special warnings

When tightening post screws, always use the tightening torques indicated below:

---

Passing screws for fastening posts to the implants	20-25 Ncm
--	-----------

---

Excessive tightening torques can weaken the screws' mechanical structure and compromise restoration stability, with potential damage to the implant connection.

## Maintenance

Some implant restoration-related complications are reported in the literature. These complications may lead to a loss of osseointegration and implant failure. Correct maintenance by the patient, good home dental care and regular sessions with a professional hygienist increase the device's service life. Complications, such as the pull-out of screws that fasten the restoration to the implants, can be easily prevented with regular check-ups. If post or prosthetic connecting screws are needed, these operations must be performed by the practitioner using suitable devices with torque tightening control. The calibration of these devices should be checked regularly.

In the event of complications of this kind, patients should contact their practitioner as soon as possible, so that the restoration can be repaired and functionality restored. A delay in contacting the doctor may lead to a fracture of the connecting screw or of the prosthesis, in the first case, and to implant failure in the second case, which could impair the rehabilitative result. Practitioners must make this clear to their patients.

Complications can be of a biological nature (loss of integration) or mechanical nature (fracture of a component due to overloading). If there are no complications, duration depends on the devices and the whole restoration system depends on mechanical resistance in relation to the fatigue accumulated by the device. Sweden & Martina has conducted 5,000,000-cycle fatigue resistance tests on its implant-post-connecting screw sets. The sets passed the test. Fatigue tests are conducted according to applicable standards and further assessed by means of finite element calculations.

## Cleaning / Sterilisation / Storage of prosthetic components and instruments

**Attention!!!** All the prosthetic components and the instruments for implants are sold NON-STERILE. Before use, such devices must be cleaned, disinfected and sterilised according to the procedures validated by Sweden & Martina S.p.A. These processes must also be performed before intraoral use, i.e. before each use for any test phases and in any case before final restoration loading. Repetition of the processes described in this paragraph does not alter the characteristics of these devices. Failure to follow these instructions may lead to cross infections.

**a. Cleaning:** Containers and transport to be used for washing: there are no special requirements.

When cleaning automatically: use an ultrasound bath with a suitable detergent solution. Use neutral detergents only. Follow the manufacturer's instructions concerning concentrations and washing times. Use demineralised water to prevent the formation of stains and marks. When draining, check the recesses of the devices, holes, etc. to make sure all residues have been completely removed. If necessary, repeat the cycle or clean manually.

When cleaning manually: use a suitable neutral detergent and follow the manufacturer's user instructions. Brush the products with a soft-bristled brush under plenty of running water. Use the brush to apply the detergent to all surfaces. Rinse with distilled water for at least four minutes. Make sure plenty of running water passes through any holes. After rinsing, dry the devices thoroughly and place them inside suitable sterilisation bags. Do not exceed 120°C when performing a drying cycle in a washing and disinfection appliance.

**b. Sterilisation:** place in a vacuum autoclave and sterilise as follows:

- Temperature = 121 – 124°C, with autoclave cycle of at least 20 minutes and drying cycle of 15 minutes.

**c. Storage:** After sterilisation, the product must remain in the sterilisation bags. The bags should only be opened immediately prior to reuse. In normal conditions, sterilisation bags maintain the sterility of the contents, unless the wrapping is damaged. Therefore, do not use components if the bags in which they were kept are damaged, and resterilise in new bags before using them again. The storage time of products sterilised inside the bags should not exceed that recommended by the manufacturer of the bags.

The product must be stored in a cool dry place, away from direct sunlight, water and heat sources.

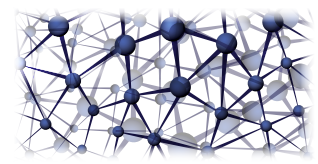

## Cleaning, sterilisation and storage of the dynamometric ratchet CRI5

The processes described below must be performed before use and before each subsequent operation. Repetition of the processes described in this paragraph has minimal effect on the wear of the device.

Failure to follow these instructions may lead to cross infections.

Containers and transport to be used for washing: there are no special requirements.

As soon as possible after each use, the key must be placed in a container filled with a disinfecting/cleansing solution and covered with a cloth. This prevents the desiccation of the contaminating agents coming from the patient, and dissolves them, thus making cleaning easier and more effective.

Completely disassemble the key as shown below:



Completely unscrew the torque adjustment screw and remove the spring inside the handle of the ratchet body. Do not separate the spring from the pin that acts as a stop.

Use the hexagon tip at the bottom of the torque adjustment screw to unscrew and completely remove the connecting screw of the cover from the side marked "OUT". Exert a light pressure in order to avoid damaging the hexagon tip.

After removing the cover, pull out the two components contained inside the ratchet head: the toothed pawl wheel and wheel stop tooth.

When cleaning manually, clean the outer and inner surfaces of the instrument mechanically under hot water with a soft bristled brush. Inject hot water using a needleless syringe to wash the hard-to-access holes of the head and the area around the wheel pawl and wheel stop. If necessary, proceed in the same way for the inside of the handle and of the torque adjustment device. Use a suitable neutral detergent and follow the manufacturer's user instructions. Use the brush to apply the detergent to all surfaces. Rinse with distilled water for at least four minutes. Make sure the running water passes abundantly through the passages. When cleaning automatically: use an ultrasound bath with a suitable detergent solution. Use neutral detergents only. Follow the manufacturer's instructions concerning concentrations and washing times. Use demineralised water to prevent the formation of stains and marks. During this cycle, avoid contact between the pieces because this causes the machined surfaces to deteriorate, and consequently, loss of precision of the torque measurement.

When draining, check the recesses of the devices, holes, etc. to make sure all residues have been completely removed. If necessary, repeat the cycle or clean manually.

Note: Blood residues or other deposits reduce the efficacy of the sterilisation process, which is why it is important to clean thoroughly. During cleaning, avoid sprays or jets of liquid and adopt adequate protections. Avoid contact between this instrument and other nickel-plated instruments. The pieces must be reassembled prior to sterilisation. Dry the parts, lubricate the functional areas lightly and reassemble the key as shown in the figures below. Too much lubrication may cause the surfaces of the instrument to resurface during sterilisation. Use only the lubricant supplied.



After lubricating the parts shown in the figure, insert the two elements of the ratchet head according to the following sequence: the toothed pawl wheel and then the wheel stop tooth.

Lubricate the contact areas between the tooth of the wheel pawl and the pin of the wheel stop tooth.

Once parts 2 and 3 have been lubricated and inserted in the head of the ratchet body, position the cover and turn the ratchet body from the "OUT" side. Tighten the screw with the hexagon tip of the torque adjustment screw.

Lubricate the spring inside the ratchet handle as shown in the figure. Assemble the torque adjustment screw, making sure the instrument functions properly. Manually activate the wheel pawl.

**Sterilisation:** in a vacuum autoclave, proceeding as follows:

Temperature = 121 – 124°C, with autoclave cycle of at least 20 minutes and drying cycle of 15 minutes.

This procedure is important in order to preserve the precision of the instrument within a tolerance of  $\pm 3.5\text{Ncm}$ . Operate the torque and insertion mechanism to check their proper functioning. Remove any traces of lubricant from the outer surface of the key. Place the device in suitable sterilisation bags. It is recommended to practise the disassembly and reassembly operations, following the instructions.

# GENERAL INDICATIONS

## Responsibility for defective products and warranty terms

Optimal patient care and attention to their needs are necessary conditions for the success of implantation procedures and, therefore, patients must be carefully selected and informed of the associated risks and obligations connected with the treatment and encouraged to cooperate with the odontologist in the interests of the success of the same treatment. The patient must, therefore, maintain good hygiene, which should be confirmed during check-up appointments, guaranteed and recorded and the practitioner's instructions and orders shall be observed. The warranty only covers manufacturing defects as long as the faulty piece is identified by the article code and batch number and returned within the validity period of the warranty.

## Warning

The prosthetic components manufactured by Sweden & Martina are designed for use with dental implants and prosthetic instruments also manufactured by Sweden & Martina. Use of non-original components limits the responsibility of Sweden & Martina S.p.A. and renders the product warranty void.

Prosthetic components must be fastened to the implants using dedicated instruments. When tightening prosthetic components, use original instruments manufactured by Sweden & Martina. Sweden & Martina declines all responsibility for use of any non-original instruments.

The instruments manufactured by Sweden & Martina are designed for use with dental implants and prosthetic components also manufactured by Sweden & Martina. Use of the instruments for working with implants other than those manufactured by Sweden & Martina limits the responsibility of Sweden & Martina and renders the product warranty void. Sweden & Martina declines all responsibility for use of any non-original instruments.

The devices in this user manual are designed and manufactured in accordance with the most recent directives and harmonised standards regarding the materials used, production processes, sterilisation, information supplied and packaging.

Marked on each package are the code, a description of the content and the batch number. These same details, which are also indicated on the labels inside the packages, must always be provided by the practitioner in any relevant correspondence.

The prosthetic components and instruments manufactured by Sweden & Martina do not contain any material of human or animal origin or phthalates.

Remember to ask patients whether they are allergic to any of the substances used.











Although very rare, titanium allergy is possible. Patients should therefore always be asked whether they are allergic to this material before use.

See pages 34-37 for detailed data sheets for all the materials used, to check the relative chemical compositions and the physical and mechanical properties.

## Disposal

If removed from the oral cavity due to biological or mechanical failure, the prosthetic components must be disposed of as biological waste. The instruments are made of small components, mostly metal. They may be disposed of as such. If dirty, they must be disposed of as biological waste. In general, the local regulations apply.

## Key of the symbols used on the packages:

symbol	description:
	Attention!!! See instruction leaflet
	Batch number
	Code
	Non sterile product (only prosthetic components and surgical instruments)
	Disposable product, do not reuse
	Manufacturer
	Consult the instruction leaflet
	CE conformity marking, class 1 products.
	CE conformity marking, class 2a and 2b products.
	American federal law restricts this device to sale by or on the order of a dental surgeon.



- Segura Andrés G, Martínez Lage J. F., Ferreiroa A., Faus López J., Agustín Panadero R.; Rehabilitación protésica en un maxilar atrófico a consecuencia de un trauma facial; *Gaceta Dental*, 2013; 244:112-118
- Canullo L, Micarelli C, Clementini M.; Hard tissue response to argon plasma cleaning treatment on titanium abutments: 2-year follow-up RCT; *European Journal of Oral Implantology*, 6 (Suppl. Spring), 2013; S21-S22
- Rossi F, Lang N. P., De Santis E., Morelli F, Favero G., Botticelli D.; Bone-healing pattern at the surface of titanium implants: an experimental study in the dog; *Clinical Oral Implant Research*, Early View, First Published online on 2013, January 4th; DOI: 10.1111/cir.120428
- Clementini M., Canullo L, Micarelli C.; Fibroblast growth on titanium disks treated by argon plasma: an in vitro triple-blinded study; *European Journal of Oral Implantology*, 6 (Suppl. Spring), 2013; S29-S30
- Canullo L, Micarelli C, Iannello G.; Microscopical and chemical surface characterization of the gingival portion and connection of an internal hexagon abutment before and after different technical stages of preparation; *Clinical Oral Implant Research*, 2013, 24: 606-611; DOI: 10.1111/j.1600-0501.2012.02499.x
- Canullo L, Heinemann F, Gedrange T, Biffar R., Kunert-Keil C.; Histological evaluation at different times after augmentation of extraction sites grafted with a magnesium-enriched hydroxyapatite: double-blinded randomized controlled trial; *Clinical Oral Implant Research*, Early View, First Published online on 2013, January 4th; DOI: 10.1111/cir.12035
- Canullo L, Micarelli C, Clementini M., Carinci F.; Cleaning procedures on customized abutments: microscopical, microbiological and chemical analysis; *Clinical Oral Implant Research*, 2012; 23 Suppl 7: 55-56; DOI: 10.1111/cir.12019, 2012, 23(s7\_128)
- Canullo L, Micarelli C, Lembo-Fazio L, Iannello G, Clementini M.; Microscopical and microbiological characterization of customized titanium abutments after different cleaning procedures; *Clinical Oral Implant Research*, Early View, First Published online on 2012, December 5th, DOI: 10.1111/cir.12089
- Wennstrom J. L., Derks J.; Is there a need for keratinized mucosa around implants to maintain health and tissue stability?; *Clinical Oral Implant Research*, 2012; 23 Suppl 6: 136-146; DOI: 10.1111/j.1600-0501.2012.0254.x
- Sisti A., Canullo L, Mottola M. P., Covani U, Barone A., Botticelli D.; Clinical evaluation of a ridge augmentation procedure for the severely resorbed alveolar socket: multicenter randomized controlled trial, preliminary results; *Clinical Oral Implant Research*, 2012; 23: 526-535; DOI: 10.1111/j.1600-0501.2011.02386.x
- Sailer I., Muhlemann S., Zwahlen M., Hammerle C. H. F., Schneider D.; Cemented and screw-retained implant reconstructions: a systematic review of the survival and complication rates; *Clinical Oral Implant Research*, 2012; 23 Suppl 6: 163-201; DOI: 10.1111/j.1600-0501.2012.02538.x
- Barone A., Orlando B., Cingano L., Marconcini S., Derchi G., Covani U.; A randomized clinical trial to evaluate and compare implants placed in augmented vs. non-augmented extraction sockets A 3-year evaluation; *Journal of Periodontology*, 2012; 83: 836-846; DOI: 10.1902/jop.2011.110205
- Sisti A., Canullo L, Mottola M. P., Iannello G.; Crestal minimally invasive sinus lift on severely resorbed maxillary crest: prospective study; *Biomedizinische Technik/Biomedical Engineering*, 2012, 57, ISSN (Online) 1862-278X, ISSN (Print) 0013-5585; DOI: 10.1515/bmt-2011-0038
- Crespi C., Cappare P., Gherlone E.; Sinus floor elevation by osteotome: hand mallet versus electric mallet. A prospective clinical study; *The International Journal of Oral & Maxillofacial Implants*, 2012; 27: 1144-50; DOI: 10.1111/j.1708-8208.2012.00485.x
- Al-Nsour M., Chan H. L., Wang H. L.; Effect of the platform-switching technique on preservation of peri implant marginal bone: a systematic review; *International Journal of Oral and Maxillofacial Implants*, 2012; 27: 138-145
- Annibaldi S., Bignozzi I., Cristalli M. P., Graziani F, La Monaca G., Polimeni A.; Peri-implant marginal bone level: a systematic review and meta-analysis of studies comparing platform switching versus conventionally restored implants; *Journal of Clinical Periodontology*, 2012; 39: 1097-1113; DOI: 10.1111/j.1600-051X.2012.01930.x
- Csonka M.; Switching Platform chirurgico e protesico; *Italian Dental Journal*, 2012; 08: 24
- Lang N. P., Pun L., Lau K. Y., Li K. Y., Wong M. C.; A systematic review on survival and success rates of implants placed immediately into fresh extraction sockets after at least 1; *Clinical Oral Implants Research*, 2012; 23 (Suppl 5): 39-66; DOI: 10.1111/j.1600-0501.2011.02372.x
- Ortega Martínez J., Pérez Pascual T., Mereque Bueno S., Hernández Alfaro F., Ferrés Padró E.; Immediate Implants following tooth extraction - A systematic review; *Medicina Oral Patología Oral y Cirugía Bucal*, 2012; 17: 251-261; DOI: 10.4317/medoral.17469
- Vignoletti F., Morante Mudarra S., Lorenzo Vignau R., Oteo Pérez A., Rodrigo Gómez D.; "Implantes inmediatos en alveolos posextracción. Factores críticos en la cicatrización de los tejidos duros y blandos"; *Maxilaris, Ciencia y Actualidad Profesional e Industrial del Sector Dental*, 2012, XV, 155: 110-126
- Bruschi G., Crespi R., Cappare P., Gherlone E.; Clinical study of flap design to increase the keratinized gingiva around implants. 4-year, follow-up; *Journal of Oral Implantology*, Early View, First published online in 2012, November; DOI: 10.1563/AID-IOI-D-11-00236.1
- Canullo L., Gotz W.; Peri-implant hard tissue response to glow-discharged abutments: Prospective study. Preliminary radiological results; *Annals of Anatomy*, 2012; 194: 174-478; DOI: org/10.1016/j.aanat.2012.03.006
- Canullo L, Micarelli C, Clementini M.; Effect of titanium abutment plasma cleaning on peri-implant bone level changes: randomized controlled trial, preliminary results; Poster, Winner, Prize Martignoni, AIOP Congress Bologna, 22-24 Novembre 2012
- Bastieri A.; espansione ossea controllata con Drill Bone Expander (D.B.E.): variabili e polifunzionalità; *Numeri Uno* 15, 2013, 10-12
- Scavia S.; Studio prospettico sul mantenimento del volume osseo verticale in impianti inseriti con tecnica M.I.S.E.; *Numeri Uno* 14, 2012, 14-15
- Crespi R., Bruschi G. B.; Vantaggi chirurgici nell'uso del Magnetic Mallet; *Numeri Uno* 13, 2012, 16-18.
- Csonka M.; Postestrattivo a carico immediato con Tecnica Simple e Platform Switching; *Numeri Uno* 12, 2012, 8-9
- Minenna F, De Leo L.; Riabilitazione impianto protesica con tecnica One Stage e protesi avvitata in materiale composito; *Numeri Uno*, 12;2012, 12-13
- Micarelli C., Canullo L., Baldissara A., Clementini M.; Abutment screw removal torque values before and after plasma cleaning; *Clinical Oral Implant Research*, 2012; 23 Suppl 7: 72; DOI: 10.1111/cir.12019, 2012, 23(s7\_162)
- Micarelli C., Canullo L., Baldissara P., Clementini M.; Abutment screw reverse torque values before and after plasma cleaning; *International Journal of Prosthodontics*, Accepted and Overview Published online, on 2012, September, 12th
- Peñarrocha Diago M., Pellicer Chover H., Peñarrocha Oltra D.; Rehabilitación con prótesis fija de arco completo maxilar mandibular sobre implantes postextracción. A propósito de un caso; *Numeri Uno* 11, 2012, 15-17
- Galli C., Piemontese M., Meikle S. T., Santini M., Macaluso G. M., Passeri G.; Biomimetic coating with phosphoserine-tethered poly(epsilon-L-lysine) dendrons on titanium surfaces enhances Wnt and osteoblastic differentiation; *Clinical Oral Implant Research*, Early View, First Published online on 2012, December 5th; DOI: 10.1111/j.1600-0501.2011.02227.x
- Bengazi F., Lang N. P., Canciani E., Viganò P., Urbizo Velez J., Botticelli D.; Osseointegration of implants with dendrimers surface characteristics installed conventionally or with Piezosurgery®. A comparative study in the dog; *Clinical Oral Implant Research*, Early View, First Published online on 2012, December 12th; DOI: 10.1111/cir.12082
- Schweikert M., Baffone G., Botticelli D., Favero G., Lavia P. P., Lang N. P.; Influence of buccal bony crest width on marginal dimensions of peri-implant tissues after implant installation in dogs; *Clinical Oral Implant Research*, 2012; 23 Suppl 7: 77-78; DOI: 10.1111/cir.12019, 2012, 23(s7\_171)
- Baffone G. M., Botticelli D., Pereira F. P., Favero G., Schweikert M., Lang N. P.; Influence of buccal bony crest width on marginal dimensions of peri-implant hard and soft tissues after implant installation. An experimental study in dogs; *Clinical Oral Implants Research*, 2013; 24: 250-254; DOI: 10.1111/j.1600-0501.2012.02512.x
- Crespi R., Cappare P., Gherlone E.; A comparison of manual and electrical mallet in maxillary bone condensing for immediately loaded implants: a randomized study; *Clinical Implant Dentistry and Related Research*, Early View, First Published online on 2012, August, 15th, DOI: 10.1111/j.1708-8208.2012.00485.x
- Calvo-Guirado J. L., Boquete-Castro A., Negri B., Delgado Ruiz R., Gomez-Moreno G., Iezzi G.; Crestal bone reactions to immediate implants placed at different levels in relation to crestal bone. A pilot study in foxhound dogs; *Clinical Oral Implant Research*, Early View, First Published online on 2013, January 25th; DOI: 10.1111/cir.12110
- Scala A., Lang N. P., Schweikert M. T., de Oliveira J. A., Rangel- Garcia I. Jr, Botticelli D.; Sequential healing of open extraction sockets. An experimental study in monkeys; *Clinical Oral Implant Research*, Early View, First Published online on 2013, April 1st; DOI: 10.1111/cir.12148
- Rossi F., Lang N. P., Favero G., Pantani F., Tschon M., Botticelli D.; Bone healing pattern at the surface of titanium implants: an experimental study in the dog; *Clinical Oral Implant Research*, 2012; 23 Suppl 7: 76-77; DOI: 10.1111/cir.12019, 2012, 23(s7\_171)
- Sivoletta S., Bressan E., Salata L. A., Urrutia Z. A., Lang N. P., Botticelli D.; Osteogenesis at implants without primary bone contact - An experimental study in dogs; *Clinical Oral Implant Research*, 2012; 23: 542-549; DOI: 10.1111/j.1600-0501.2012.02423.x
- Sivoletta S., Bressan E., Salata L. A., Quinones M. E., Urrutia Z. A., Lang N. P., Botticelli D.; Deproteinized bovine bone mineral particles and osseointegration of implants without primary bone contact: an experimental study in dogs; *Clinical Oral Implant Research*, Early View, First Published online on 2013, April 8th; DOI: 10.1111/cir.12154
- Caneva M., Botticelli D., Viganò P., Morelli F., Rea M., Lang N. P.; Connective tissue grafts in conjunction with implants installed immediately into extraction sockets. An experimental study in dogs; *Clinical Oral Implant Research*, 2013; 24: 50-56; DOI: 10.1111/j.1600-0501.2012.02450.x
- De Santis E., Lang N. P., Cesaretti G., Mainetti T., Beolchini M., Botticelli D.; Healing outcomes at implants installed in sites augmented with particulate autologous bone and xenografts. An experimental study in dogs; *Clinical Oral Implants Research*, 2013; 24: 77-86; DOI: 10.1111/j.1600-0501.2012.02456.x
- Negri M., Lumetti S., Manfredi E., Galli C., Chiacchi G., Macaluso G. M.; Marginal bone remodelling of Sweden&Martina Premium implants: 2-years clinical results; *Clinical Oral Implant Research*, 2012; 23 Suppl 7: 98; DOI: 10.1111/cir.12019, 2012, 23(s7\_218)
- Cosyn J., Hooghe H., De Bruyn H.; A systematic review on the frequency of advanced recession following single Immediate Implant treatment; *Journal of Clinical Periodontology*, 2012 Jun; 39: 582-589; DOI: 10.1111/j.1600-051X.2012.01888.x
- Covani U., Chiappe G., Bosco M., Orlando B., Quaranta A., Barone A.; A 10-year evaluation of implants placed in fresh extraction sockets: a prospective cohort study; *Journal of Periodontology*, 2012; 83: 1226-1234; DOI: 10.1902/jop.2012.110583
- Covani U., Ricci M., D'Ambrosio N., Quaranta A., Barone A.; Changes in soft tissues around immediate full-arch rehabilitations: a prospective study; *Clinical Oral Implant Research*, Early View, First Published online on 2012, January, 6th; DOI: 10.1111/j.1600-0501.2011.02394.x
- Crespi R., Cappare P., Gherlone E., Romanos G.; Immediate provisionalization of dental implants placed in fresh extraction sockets using a flapless technique; *The International Journal of Periodontics & Restorative Dentistry*, 2012; 32: 29-37
- Morelli F.; Rigenerazione ossea orizzontale e verticale peri-implantare con mesh in titanio ed osso autogeno; *Numeri Uno* 11; 2011, 7-9
- Crespi R., Cappare P., Gherlone E.; Electrical mallet provides essential advantages in maxillary bone condensing. A prospective clinical study; *Clinical Implant Dentistry and Related Research*, Early View, First Published online on 2012, January, 11th, DOI: 10.1111/j.1708-8208.2011.00432.x
- Galli C., Macaluso G.M., Elezi E., Ravanetti F., Cacchioli A., Gualini G., Passeri G.; The Effects of Er:YAG Laser Treatment on Titanium Surface Profile and Osteoblastic Cell Activity: An In Vitro Study; *Journal of Periodontology*, 82 (8): 1169-1177, 2011; DOI: 10.1902/jop.2010.100428
- Ramaglia L., Postiglione L., Di Spigna G., Capece G., Salzano S., Rossi G.; Sandblasted-acid-etched titanium surface influences in vitro the biological behavior of SaOS-2 human osteoblast-like cells; *Dental Material Journal*, 30: 183-192, 2011; DOI:10.4012/dmj.2010-107
- Scala A., Botticelli D., Faeda R.S., Rangel I.G. Jr, de Oliveira J.A., Lang N.P.; Lack of influence of the Schneiderian membrane in forming new bone apical to implants simultaneously installed with sinus floor elevation: an experimental study in monkeys; *Clinical Oral Implant Research*, Early View, First Published online on 2011, June 13th; DOI: 10.1111/j.1600-0501.2011.02227.x
- Rossi F., Botticelli D., Pantani F., Pereira F.P., Salata L.A., Lang N.P.; Bone healing pattern in surgically created circumferential defects around submerged implants: an experimental study in dog; *Clinical Oral Implant Research*, Early View, First Published online on 2011, March 28th; DOI: 10.1111/j.1600-0501.2011.02170.x
- Caneva M., Botticelli D., Pantani F., Baffone G.M., Rangel I.G. Jr., Lang N.P.; Deproteinized bovine bone mineral in marginal defects at implants installed immediately into extraction sockets: an experimental study in dogs; *Clinical Oral Implant Research*, Early View, First Published online on 2011, May 5th; DOI: 10.1111/j.1600-0501.2011.02202.x
- De Santis E., Botticelli D., Pantani F., Pereira F.P., Beolchini M., Lang N.P.; Bone regeneration at implants placed into extraction sockets of maxillary incisors in dogs; *Clinical Oral Implant Research*, 2012, 2011; 430-437; DOI: 10.1111/j.1600-0501.2010.02122.x
- De Santis E., Lang N.P., Scala A., Viganò P., Salata L.A., Botticelli D.; Healing outcomes at implants installed in grafted sites: an experimental study in dogs; *Clinical Oral Implant Research*, Early View, First Published online on 2011, October 3rd; DOI: 10.1111/j.1600-0501.2011.02326.x
- Caneva M., Botticelli D., Morelli F., Cesaretti G., Beolchini M., Lang N.P.; Alveolar process preservation at implants installed immediately into extraction sockets using deproteinized bovine bone mineral - an experimental study in dogs; *Clinical Oral Implant Research*, Early View, First Published online on 2011, October 21st; DOI: 10.1111/j.1600-0501.2011.02332.x
- Caneva M., Botticelli D., Rossi F., Carvalho Cardoso L., Pantani F., Lang N.P.; Influence of implants with different sizes and configurations installed immediately into extraction sockets on peri-implant hard and soft tissues: an experimental study in dogs; *Clinical Oral Implant Research*, Early View, First Published online on 2011, September 29th; DOI: 10.1111/j.1600-0501.2011.02310.x
- Vignoletti F., De Sanctis M., Sanz M.; Impianti immediati post-estrattivi: fattori critici per la guarigione dei tessuti; *Il Dentista Moderno*, 9:94-114, 2011
- Farronato D., Santoro G., Canullo L., Botticelli D., Maiorana C., Lang N.P.; Establishment of the epithelial attachment and connective tissue adaptation to implants installed under the concept of "platform switching": a histologic study in minipigs; *Clinical Oral Implant Research*, Early View, First Published online on 2011, April 15th; DOI: 10.1111/j.1600-0501.2011.02196.x
- Baffone G.M., Botticelli D., Pantani F., Cardoso L.C., Schweikert M.T., Lang N.P.; Influence of various



# BIBLIOGRAPHY ON SWEDEN & MARTINA IMPLANTS

- implant platform configurations on peri-implant tissue dimensions: an experimental study in dog; *Clinical Oral Implant Research* 22, 2011; 438-444; DOI: 10.1111/j.1600-0501.2010.02146.x
- Canullo L., Pellegrini G., Allievi C., Trombelli L., Annibaldi S., Dellavia C.; Soft tissues around long-term platform switching implant restorations: a histological human evaluation. Preliminary results; *Journal of Clinical Periodontology*, 2011; 38: 86-94; DOI: 10.1111/j.1600-051X.2010.01641.x
- Canullo L., Iannello G., Netuschil L., Jepsen S.; Platform switching and matrix metalloproteinase-8 levels in peri-implant sulcular fluid; *Clinical Oral Implant Research, Early View*, First Published online on 2011, March 28th; DOI: 10.1111/j.1600-0501.2011.02175.x
- Della Via C., Canullo L., Allievi C., Lang N.P., Pellegrini C.; Soft tissue surrounding switched platform implants: an immunohistochemical evaluation; *Clinical Oral Implant Research, Early View*, First Published online on 2011, September 29th; DOI: 10.1111/j.1600-0501.2011.02301.x
- Baffone G.M., Botticelli D., Canullo L., Scala A., Beolchini M., Lang N.P.; Effect of mismatching abutments on implants with wider platforms - an experimental study in dogs; *Clinical Oral Implant Research, Early View* First Published online on 2011, November 2nd; DOI: 10.1111/j.1600-0501.2011.02320.x
- Canullo L., Pace F., Coelho P., Sciubba E., Vozza I.; The Influence of Platform Switching on the Biomechanical Aspects of the Implant-Abutment System. A Three Dimensional Finite Element Study; *Med Oral Patol Oral Cir Bucal*. 2011 Sep 1;16 (6):e852-6; DOI: 10.4317/medoral.17243
- Canullo L., Iannello G., Götz W.; The influence of individual bone patterns on peri-implant bone loss: preliminary report from a 3-year randomized clinical and histologic trial in patients treated with implants restored with matching-diameter abutments or the platform-switching concept; *International Journal of Oral and Maxillofacial Implants*, 2011 May-Jun;26(3):618-30
- Serrano-Sánchez P., Calvo-Guirado J.L., Manzanera-Pastor E., Llorio-Castro C., Bretones-López P., Pérez-Llanes J.A.; The influence of platform switching in dental implants. A literature review; *Medicina Oral Patología Oral Cirugía Bucal*. 2011 May 1;16 (3):e400-5; DOI: 10.4317/medoral.16.e400
- Bruschi G.B., Crespi R., Cappare P., Bravi F., Bruschi E., Gherlone E.; Localized Management of Sinus Floor Technique for Implant Placement in Fresh Molar Sockets; *Clinical Implant Dentistry and Related Research*, 2011 May 20. [Epub ahead of print]; DOI: 10.1111/j.1708-8208.2011.00348.x
- Sisti A., Canullo L., Mottola M.P., Iannello G.; A case series on crestal sinus elevation with rotary instruments; *European Journal of Oral Implantology*. 2011 Summer;4(2):145-52
- García-Fajardo Palacios C.; Sinus Lift. Ottimizzazione dei risultati; *NumeriUno* 10(06), 2011, 04-07
- Canullo L.; RIGENERAZIONE DI UN SITO POST-ESTRATTIVO con grave deficit osseo vestibolare con idrossiapatite arricchita di magnesio. CASE REPORT CON FOLLOW UP DEL RESTAURO IMPLANTO-PROTESICO A 2 ANNI; *Odontoiatria - Rivista degli Amici di Brugg*, 2: 166-167, 2011
- Becattelli A., Biscaro L., Ferlin P., Soattin M.; Riabilitazione implanto-protesica di entrambe le arcate mediante Toronto Bridge su impianti tiltati a carico immediato; *NumeriUno* 10(06) 2011, 10-12
- Marano G., Tomarelli F.; Carico implantare immediato e condizionamento dei tessuti molli con provvisorio in ceramica; *NumeriUno* 10 (06) 2011, 18-21
- Avanzo P., Fabrocini L., Avanzo A., Ciavarella D., Lo Muzio L., De Maio R.; Use of intra-oral welding to stabilize dental implants in augmented sites for immediate provisionalization: a case report; *Journal of Oral Implantology*, 2010 Oct 8. [Epub ahead of print]; DOI: 10.1563/AID-JOI-D-10-00047
- Dominici A.D.; Solidarizzazione elettronica su impianti a carico immediato: un caso clinico in chirurgia flapless; *Dental Cadmos*, 79(8):545-550, 2011; DOI: 10.1016/j.cadmos.2011.03.002
- De Paolis G., Quaranta A., Zappia S., Vozza I., Quaranta M.; Valutazione clinica e microbiologica di impianti a connessione conometrica rispetto a impianti a connessione esagonale: caso clinico; *Dental Cadmos*, 79(7):443-454, 2011; DOI: 10.1016/j.cadmos.2010.11.010
- Canullo L., Bignozzi I., Cocchetto R., Cristalli M.P., Iannello G.; Immediate positioning of a definitive abutment versus repeated abutment replacements in post-extractive implants: 3-year follow-up of a randomised multicentre clinical trial; *European Journal of Oral Implantology*, 2010 Winter;3(4):285-96
- Csonka M.; Carico Immediato di una Cresta Mandibolare Edentula con Tecnica SIMPLE; *Italian Dental Journal*, 2011
- Canullo L., Baffone G.M., Botticelli D., Pantani F., Beolchini M., Lang N.P.; Effect of wider implant/abutment mismatching: an histological study in dogs; *Clinical Oral Implant Research*, 22(9), 2011:910; DOI: 10.1111/j.1600-0501.2011.02271.x
- Rossi F., Botticelli D., Salata L.; Bone healing in animal surgically created circumferential defects around submerged implants; *Clinical Oral Implant Research*, 22(9), 2011: 937; DOI: 10.1111/j.1600-0501.2011.02271.x
- Ricci M., Funel N., Orazio V., Bobbio A., Barone A., Covani U.; Analysis of osteoblastic gene dynamics in the early human mesenchymal cell response to an implant support: an in vitro study; *Clinical Oral Implant Research*, 22(9), 2011: 1071; DOI: 10.1111/j.1600-0501.2011.02271.x
- Canullo L., Gotz W.; Cell growth on titanium disks treated by plasma of Argon: experimental study; *Clinical Oral Implant Research*, 22(9), 2011: 1082-3; DOI: 10.1111/j.1600-0501.2011.02271.x
- Bruschi G.B., Crespi R.; TECNICHE DI ESPANSIONE OSSEA IN CHIRURGIA IMPLANTARE; Quintessenza Edizioni S.r.l., 2011, Milano (Anteprima)
- Avellino W., Milan U., Delle Rose D.; SOLUZIONI CLINICHE E TECNICHE PER LA REALIZZAZIONE DI UN PROVVISORIO FULL-ARCH SU IMPIANTI CON FUNZIONE IMMEDIATA; *NumeriUno*, 7: 11-13, 2010
- Branchi R., Vangi D., Virga A., Guertin G., Fazi G.; RESISTANCE TO WEAR OF FOUR MATRICES WITH BALL ATTACHMENTS FOR IMPLANT OVERDENTURES: A FATIGUE STUDY; *Journal of Prosthodontics*, 19(8):614-619, 2010
- Bruschi G.B., Crespi R., Cappare P., Gherlone E.; TRANSCRESTAL SINUS FLOOR ELEVATION: A RETROSPECTIVE STUDY OF 46 PATIENTS UP TO 16 YEARS; *Clinical Implant Dentistry and Related Research*, 2010 Oct 26
- Caneva M., Salata L.A., Scombatti de Souza S., Baffone G., Lang N.P., Botticelli D.; INFLUENCE OF IMPLANT POSITIONING IN EXTRACTION SOCKETS ON OSSEointegration: HISTOMORPHOMETRIC ANALYSES IN DOGS; *Clinical Oral Implant Research* 21; 43-49, 2010
- Caneva M., Salata L.A., Scombatti de Souza S., Bressan E., Botticelli D., Lang N.P.; HARD TISSUE FORMATION ADJACENT TO IMPLANTS OF VARIOUS SIZE AND CONFIGURATION IMMEDIATELY PLACED INTO EXTRACTION SOCKETS: AN EXPERIMENTAL STUDY IN DOGS; *Clinical Oral Implant Research*, 21(9):885-90, 2010
- Caneva M., Botticelli D., Stellini E., Souza S.L., Salata L.A., Lang N.P.; MAGNESIUM-ENRICHED HYDROXYAPATITE AT IMMEDIATE IMPLANTS: A HISTOMORPHOMETRIC STUDY IN DOGS; *Clinical Oral Implant Research, Early View*, first published online 2010 Dec 9
- Caneva M., Botticelli D., Salata L.A., Scombatti de Souza S., Carvalho Cardoso L., Lang N.P.; COLLAGEN MEMBRANES AT IMMEDIATE IMPLANTS: A HISTOMORPHOMETRIC STUDY IN DOGS; *Clinical Oral Implant Research*, 21(9):891-7, 2010
- Caneva M., Botticelli D., Salata L.A., Scombatti de Souza S., Bressan E., Lang N.P.; FLAP VS. "FLAPLESS" SURGICAL APPROACH AT IMMEDIATE IMPLANTS: A HISTOMORPHOMETRIC STUDY IN DOGS; *Clinical Oral Implant Research*, 21 (12):1314-1319, 2010
- Canullo L., Quaranta A., Teles R.P.; THE MICROBIOTA ASSOCIATED WITH IMPLANTS RESTORED WITH PLATFORM SWITCHING: A PRELIMINARY REPORT; *Journal of Periodontology*, 81:403-411, 2010
- Canullo L., Rossi Fedele G., Iannello G., Jepsen S.; PLATFORM SWITCHING AND MARGINAL BONE-LEVEL ALTERATIONS: THE RESULTS OF A RANDOMIZED CONTROLLED TRIAL; *Clinical Oral Implant Research*, 21:115-121, 2010
- Canullo L., Bignozzi I., Cocchetto R.; "ONE ABUTMENT-ONE TIME": OPTIMIZING PLATFORM-SWITCHING CONCEPT. THREE-YEAR CONTROLLED PROSPECTIVE STUDY; *Clinical Oral Implant Research*, 21 (10): 1085, 2010
- Canullo L.; CASO CLINICO: AGENESIA DELL'INCISIVO LATERALE SUPERIORE DESTRO; *Italian Dental Journal*, 4: 16, 2010
- Canullo L., Cocchetto R., Loi I.; PERI-IMPLANT TISSUES REMODELING: SCIENTIFIC BACKGROUND & CLINICAL IMPLICATIONS; Quintessenza Edizioni S.r.l., 2010, Milano (Anteprima)
- Canullo L., Sisti A.; EARLY IMPLANT LOADING AFTER VERTICAL RIDGE AUGMENTATION (VRA) USING E-PTEFEE TITANIUMREINFORCED MEMBRANE AND NANOSTRUCTURED HYDROXYAPATITE: 2-YEAR PROSPECTIVE STUDY; *European Journal Oral Implantology*, 3(1):59-69, 2010
- Canullo L., Patacchia O., Sisti A., Heinemann F.; IMPLANT RESTORATION 3 MONTHS AFTER ONE STAGE SINUS LIFT SURGERY IN SEVERELY RESORBED MAXILLAE: 2-YEAR RESULTS ON A MULTI-CENTER PROSPECTIVE CLINICAL STUDY; *Clinical Implant Dentistry and Related Research, Early view* - Published online in ahead of printing, 21-10-2010
- Ciccù M., Risitano G., Maiorana C., Herford A., Oteri G., Ciccù D.; "TORONTO" SCREWED MANDIBULAR OVERDENTURE ON DENTAL IMPLANTS: FEM AND VON MISES ANALYSIS OF STRESS DISTRIBUTION; *The Journal of Implants and Advanced Dentistry*, 2(9): 41-58, 2010
- Covani U., Marconcini S., Santini S., Cornelini R., Barone A.; IMMEDIATE RESTORATION OF SINGLE IMPLANTS PLACED IMMEDIATELY AFTER IMPLANT REMOVAL. A CASE REPORT; *International Journal of Periodontics & Restorative Dentistry*, 30:639-645, 2010
- Crespi R., Cappare P., Gherlone E.; OSTEOTOMY SINUS FLOOR ELEVATION AND SIMULTANEOUS IMPLANT PLACEMENT IN GRAFTED BIOMATERIAL SOCKETS: 3 YEARS OF FOLLOW-UP; *Journal of Periodontology*, 81:344-349, 2010
- Crespi R., Cappare P., Gherlone E.; A 4-YEAR EVALUATION OF THE PERI-IMPLANT PARAMETERS OF IMMEDIATE LOADED IMPLANTS PLACED IN FRESH EXTRACTION SOCKETS; *Journal of Periodontology*, 81 (11):1629-1634, 2010
- Crespi R., Cappare P., Gherlone E.; IMMEDIATE LOADING OF DENTAL IMPLANTS PLACED IN PERIODONTALLY INFECTED AND NON INFECTED SITES IN HUMANS: A FOUR YEARS FOLLOW-UP CLINICAL STUDY; *Journal of Periodontology*, 81 (8):1140-1146, 2010
- Crespi R., Cappare P. and Gherlone E.; FRESH-SOCKET IMPLANTS IN PERIAPICAL INFECTED SITES IN HUMANS; *Journal of Periodontology*, 81:378-383, 2010
- Galli C., Passeri G., Piemontese M., Lumetti S., Manfredi E., Carra M.C., Macaluso G.M.; PHOSPHOSERINE-POLY (LYSINE) COATINGS PROMOTE OSTEOBLASTIC DIFFERENTIATION AND WNT SIGNALING ON TITANIUM SUBSTRATES; *Clinical Oral Implant Research*, 21(10): 1172, 2010
- Mantoan G.; LE CORONE PROVVISORIE IMMEDIATE SU IMPIANTI GLOBAL (METODICA CLINICA); *NumeriUno*, 7: 17-18, 2010
- Momen A., Hadeel M. I., Ahmad H. A.; PLATFORM SWITCHING FOR MARGINAL BONE PRESERVATION AROUND DENTAL IMPLANTS: A SYSTEMATIC REVIEW AND META-ANALYSIS; *Journal of Periodontology*, 81 (10):1350-1366, 2010
- Pantani F., Botticelli D., Rangel Garcia I. Jr., Salata L.A., Jayme Borges G., Lang N. P.; INFLUENCE OF LATERAL PRESSURE TO THE IMPLANT BED ON OSSEointegration: AN EXPERIMENTAL STUDY IN DOGS; *Clinical Oral Implant Research*, 21(11): 1264-70, 2010
- Passeri G., Cacchioli A., Ravanetti F., Galli C., Elezi E., Macaluso G.M.; ADHESION PATTERN AND GROWTH OF PRIMARY HUMAN OSTEOBLASTIC CELLS ON FIVE COMMERCIALY AVAILABLE TITANIUM SURFACES; *Clinical Oral Implant Research* 21: 756-765, 2010
- Raddi F.; ANALISI COMPARATIVA TEST DI RESISTENZA A FATICA SPERIMENTALI E VIRTUALI; Relazione interna, Sweden & Martina, 2010
- Scala A., Botticelli D., Oliveira J.A., Okamoto R., Garcia Rangel I. Jr., Lang N.P.; EARLY HEALING AFTER ELEVATION OF THE MAXILLARY SINUS FLOOR APPLYING A LATERAL ACCESS - A HISTOLOGICAL STUDY IN MONKEYS; *Clinical Oral Implant Research*, 21 (12): 1320-6, 2010
- Silvasan M.H.; TIMING OF DENTAL IMPLANT LOADING - A LITERATURE REVIEW; *Implants - Oemus*, 11 (3): 06-16, 2010
- Sbordone L., Levin L., Guidetti F., Sbordone C., Glikman A., Schwartz-Arad D.; APICAL AND MARGINAL BONE ALTERATIONS AROUND IMPLANTS IN MAXILLARY SINUS AUGMENTATION GRAFTED WITH AUTOGENOUS BONE OR BOVINE BONE MATERIAL AND SIMULTANEOUS OR DELAYED DENTAL IMPLANT POSITIONING; *Clinical Oral Implants Research*, 2010 Nov 19. [Epub ahead of print]
- Ballini D., Attini M., Giunta S., Mezzanotte E.; MINI IMPIANTI: UN CASE REPORT; *NumeriUno*, 5: 18-20, 2009
- Biscaro L., Becattelli A., Soattin M.; RIABILITAZIONE IMPLANTO-PROTESICA DELLE DUE ARCADE CON CARICO IMMEDIATO: PROTOCOLLO DI LAVORO CON L'UTILIZZO DELLA TECNICA DEL MODELLO UNICO E DELLA SISTEMATICA PAD; *NumeriUno*, 8, 04-05, 2009
- Briguglio F., Briguglio E., Sidoti Pinto G.A., Lapi M., Zappia D., Briguglio R.; VALUTAZIONE CLINICA COMPARATIVA SULL'UTILIZZO DI UN COPOLIMERO DELL'ACIDO POLIGLICOLICO E POLILATTICO NEL SINUS LIFT; *Implantologia*.1:9-14, 2009
- Bruschi G. B., Bravi F., Di Felice A.; RIABILITAZIONE PROTESICA SU DENTI E IMPIANTI MEDIANTE TECNICHE CHIRURGICHE DI ESPANSIONE CRESTALE E SOLLEVAMENTO DEL SENO E CHIRURGIA PROTETICAMENTE GUIDATA; *NumeriUno*, 5: 8-14, 2009
- Calesini G., Micarelli C., Coppe S., Scipioni A.; EDENTULOUS SITE ENHANCEMENT: A REGENERATIVE APPROACH TO THE MANAGEMENT OF EDENTULOUS AREAS. PART 2- PERI-IMPLANT TISSUES; *International Journal of Periodontics & Restorative Dentistry*, 29(1):49-57, 2009
- Canullo L., Iurlaro G., Iannello G.; DOUBLE-BLIND RANDOMIZED CONTROLLED TRIAL STUDY ON POSTEXTRACTION IMMEDIATELY RESTORED IMPLANTS USING THE SWITCHING PLATFORM CONCEPT: SOFT TISSUE RESPONSE. PRELIMINARY REPORT; *Clinical Oral Implant Research*, 20 (4):414-420, 2009
- Canullo L., Goglia G., Iurlaro G., and Iannello G.; SHORT-TERM BONE LEVEL OBSERVATIONS ASSOCIATED WITH PLATFORM SWITCHING IN IMMEDIATELY PLACED AND RESTORED SINGLE MAXILLARY IMPLANTS: A PRELIMINARY REPORT; *International Journal of Prosthodontics*, 22 (3):277-282, 2009
- Canullo L., Iannello G., Jepsen S.; MATRIX-METALLOPROTEINASES AND BONE LOSS AT IMPLANTS RESTORED ACCORDING TO THE PLATFORM SWITCHING CONCEPT: A RANDOMIZED CONTROLLED TRIAL ON THE INFLUENCE OF DIFFERENT MISMATCHING; *Clinical Oral Implant Research*, 20(9):873-874, 2009
- Canullo L., Vozza I., Caricato F., Dellavia C.; MAXILLARY SINUS FLOOR AUGMENTATION USING A NANO-CRYSTALLINE HYDROXYAPATITE SILICA GEL. A PROSPECTIVE STUDY - HISTOLOGICAL RESULTS AFTER 3 MONTHS OF HEALING; *Implants* 2, 24-27, 2009
- Cardelli P., Montani M., Gallio M., Biancolini M., Brutti C., Barlattani A.; ABUTMENTS ANGOLATI E TENSIONI PERIMPLANTARI: ANALISI F.E.M.; *Oral Implantology*, 1:7-14, 2009
- Carinci F., Guidi R., Franco M., Viscioni A., Rigo L., De Santis B., Tropina E.; IMPLANTS INSERTED IN FRESH-FROZEN BONE: A RETROSPECTIVE ANALYSIS OF 88 IMPLANTS LOADED 4 MONTHS AFTER INSERTION; *Quintessenza International*, 40(5): 413-419, 2009
- Carusi G., Sisti A., Mottola M.P., Matera G., Veruggio P., Gelmi L., Bailo A.; TECNICA DI RIALZO DI SENO MINIMAMENTE INVASIVA NEL TRATTAMENTO IMPLANTARE DEL MASCELLARE EDENTULO; *Dental Cadmos*, 77(10): 31-40, 2009
- Ceccherini A., De Angelis L., Silvestrelli S.; CHIRURGIA SOFTWARE ASSISTITA CON LA TECNICA MODEL GUIDE: PROGETTO 3D - POSA DELL'IMPIANTO GUIDATA; *TeamWork*, 11(6), 63:75, 2009
- Ciccù M., Risitano G., Maiorana C., Franceschini G.; PARAMETRIC ANALYSIS OF THE STRENGTH IN





- THE "TORONTO" OSSEOUS-PROSTHESIS SYSTEM; *Minerva Stomatologica*, 58(1-2):9-23, 2009
- Covani U.; I VANTAGGI DELL'IMPIANTO PREMIUM/KOHNO NELLA CHIRURGIA SOSTITUTIVA DELL'ARCATA DENTARIA; Atti del Congresso, X Congresso Nazionale di Implantoprotesi Integrata Premium Day 2009, 18-20 giugno 2009, Abano Terme, pp. 14-15
- Crespi R., Cappare P., Gherlone E.; RADIOGRAPHIC EVALUATION OF MARGINAL BONE LEVELS AROUND PLATFORM-SWITCHED AND NON-PLATFORM-SWITCHED IMPLANTS USED IN AN IMMEDIATE LOADING PROTOCOL; *The International Journal of Oral and Maxillofacial Implants*, 24:920-926, 2009
- Crespi R., Cappare P., Gherlone E.; DENTAL IMPLANTS PLACED IN EXTRACTION SITES GRAFTED WITH DIFFERENT BONE SUBSTITUTES: RADIOGRAPHIC EVALUATION AT 24 MONTHS; *Journal of Periodontology*, 80 (10):1616-1621, 2009
- Figliuzzi M.; LA TECNICA FLAPLESS: INDICAZIONI E LIMITI; *NumeriUno*, 3 (12-3); 2009, 04-07
- Lenzi C.; LA RIGENERAZIONE DEI DIFETTI OSSEI NEI SITI POSTESTRATTIVI MEDIANTE OSSO BOVINO DEPROTEINIZZATO. VALUTAZIONE DELLE DIFFERENTI TECNICHE CHIRURGICHE; *Implantologia*, 1: 51-59, 2009
- Maiorana C., Ciccù M., Andreoni D., Beretta M.; CARICO IMMEDIATO DI DENTE SINGOLO: CASO CLINICO E REVISIONE DELLA LETTERATURA; *Journal of Osseointegration*, 2(1): 1-10, 2009
- Maiorana C., Ciccù M., Beretta M., Andreoni D.; RISULTATI DEL TRATTAMENTO CON CARICO FUNZIONALE PRECOCE SU PROTESI TORONTO DOPO IL POSIZIONAMENTO DI IMPIANTI IN SITI POSTESTRATTIVI; *Journal of Osseointegration*, 2(1): 95-100, 2009
- Mazzella M., Prota V., Mazzella A.; IL PONTIC A CONFORMAZIONE OVOIDALE IN PROTESI IMPIANTATE; *NumeriUno*, 6: 6-7, 2009
- Monguzzi R., Pozzi E., Franceschini F. G.; PROTESI IN ZIRCONIO SU IMPIANTI ED ELEMENTI NATURALI; *NumeriUno*, 6, 04-05, 2009
- Paniz G.; L'UTILIZZO DELLA TECNOLOGIA CAD-CAM ECHO PER IL TRATTAMENTO PROTESICO DI TIPO CEMENTATO DELLE EDENTULIE SINGOLE IN ZONA ESTETICA; *NumeriUno*, 4 (4-6):04-05, 2009
- Quaranta A., Maida C., Scarscia A., Campus G., Quaranta A.; ER:YAG LASER APPLICATION ON TITANIUM IMPLANT SURFACES CONTAMINATED BY PORPHYROMONAS GINGIVALIS: AN HISTOMORPHOMETRIC EVALUATION; *Minerva Stomatologica*, 58:317-30, 2009
- Ricci M., Tonelli P., Barone A., Covani U.; RUOLO DEL PLATFORM SWITCHING NEL MANTENIMENTO DELL'OSSO PERIMPLANTARE; *Dental Cadmos*, 77(9): 31-39, 2009
- Severi G.; CARICO PRECOCE DI IMPIANTI DENTALI CHE SOSTENGONO UNA PROTESI FISSA NELLA MANDIBOLA POSTERIORE EDENTULA; *NumeriUno*, 4: 6-8, 2009
- Barone A., Cornelini R., Ciaglia R., Covani U.; IMPLANT PLACEMENT IN FRESH EXTRACTION SOCKETS AND SIMULTANEOUS OSTEOTOME SINUS FLOOR ELEVATION: A CASE SERIES; *International Journal of Periodontics Restorative Dentistry*, 28(3):283-9, 2008
- Bosio C.; CARICO IMMEDIATO MANDIBOLARE; *NumeriUno*, 0: 7-9, 2008
- Canullo L., Malagnino G., Iurlaro G.; RIABILITAZIONE PROTESICA DI IMPIANTI SINGOLI A CARICO IMMEDIATO: STUDIO PROSPETTICO; *Dental Cadmos*, 76(6): 1-8, 2008
- Canullo L., Nuzzoli A., Marinotti F.; TECNICHE DI REALIZZAZIONE DI UN PROVVISORIO SU MONOIMPIANTO A CARICO IMMEDIATO; *Implantologia*, 1: 21-29, 2008
- Canullo L.; PLATFORM SWITCHING E CARICO IMMEDIATO SUL DENTE SINGOLO IN ZONA ESTETICA; *NumeriUno*, 1: 6-7, 2008
- Ciccù M., Beretta M., Risitano G., Maiorana C.; CEMENTED-RETAINED VS SCREW-RETAINED IMPLANT RESTORATIONS: AN INVESTIGATION ON 1939 DENTAL IMPLANTS; *Minerva Stomatol*, 57(4):167-79, 2008
- Covani U., Barone A., Cornelini R.; BUCCAL BONE AUGMENTATION AROUND IMMEDIATE IMPLANTS WITH AND WITHOUT FLAP ELEVATION: A MODIFIED APPROACH; *International Journal Oral and Maxillofacial Implants*, 23:841-846, 2008
- Crespi R.; CARICO IMMEDIATO IN IMPLANTOPROTESI. PROTOCOLLI SPERIMENTALI E APPLICAZIONI CLINICHE; Quintessenza Edizioni S.r.l., 2008, Milano
- Crespi R., Cappare P., Gherlone E., Romanos G.E.; IL CARICO IMMEDIATO IN IMPIANTI POSTESTRATTIVI IMMEDIATI; *Implantologia*, anno 6, marzo 2008
- Crespi R., Cappare P., Gherlone E., Romanos G.E.; IMMEDIATE VERSUS DELAYED LOADING OF DENTAL IMPLANTS PLACED IN FRESH EXTRACTION SOCKETS IN THE MAXILLARY ESTHETIC ZONE: A CLINICAL COMPARATIVE STUDY; *International Journal of Oral Maxillofacial Implants*, 23:753-758, 2008
- Lenzi C. C.; LA RIABILITAZIONE IMPLANTOPROTESICA FUNZIONALE ED ESTETICA CON SINUS LIFT MONOLATERALE. CASE REPORT; *Implantologia*, 4:63-65, 2008
- Risitano G., Franceschini G., Ciccù M., Maiorana C.; ANALISI PARAMETRICA DELL'EFFICIENZA DEL SISTEMA PROTESI TIPO "TORONTO"; XXXVII Convegno Nazionale, AIAS Associazione Italiana per l'Analisi delle Sollecitazioni, 10-13 settembre 2008, Università di Roma la Sapienza, Atti del Congresso
- Scipioni A., Calesini G., Micarelli C., Coppe S., Scipioni L.; MORPHOGENIC BONE SPLITTING: DESCRIPTION OF AN ORIGINAL TECHNIQUE AND ITS APPLICATION IN AESTHETICALLY SIGNIFICANT AREAS; *The International Journal of Prosthodontics*, 21(5):389-397, 2008
- Tagliani M., Morandini E.; RIABILITAZIONE IMPLANTO-PROTESICA BIMASCELLARE DI UN PAZIENTE CON GRAVE ATROFIA OSSEA MEDIANTE TECNICA DI ESPANSIONE CRESTALE ASSOCIATA A CARICO IMMEDIATO NELL'ARCATA INFERIORE E A RIALZO DI SENO MASCELLARE LOCALIZZATO CON APPROCCIO CRESTALE; *NumeriUno*, 2(10-12):04-06, 2008
- Covani U., Marconcini S., Galassini G., Cornelini R., Santini S., Barone A.; CONNECTIVE TISSUE GRAFT USED AS A BIOLOGIC BARRIER TO COVER AN IMMEDIATE IMPLANT; *Journal of Periodontology*, 78:1644-1649, 2007
- Covani U., Barone A., Cornelini R.; VERTICAL CRESTAL BONE CHANGES AROUND IMPLANTS PLACED INTO FRESH EXTRACTION SOCKETS; *Journal of Periodontology*, 78:810-815, 2007
- Crespi R., Cappare P., Gherlone E., Romanos G.E.; IMMEDIATE OCCLUSAL LOADING OF IMPLANTS PLACED IN FRESH SOCKETS AFTER TOOTH EXTRACTION; *International Journal of Oral Maxillofacial Implants*, 22:955-962, 2007
- Elezi E., Galli C., Passeri G., Lumetti S., Manfredi E., Bonanini M., Macaluso G.M.; IL COMPORTAMENTO DEGLI OSTEOBLASTI UMANI SU SUPERFICI DI TITANIO TRATTATE IN MODO DIVERSO; IADR General Session & Exhibition - Abstract Collection, 2007
- Pappalardo S., Milazzo I., Nicoletti G., Baglio O., Blandino G., Scalini L., Mastrangelo F., Tete S.; DENTAL IMPLANTS WITH LOCKING TAPER CONNECTION VERSUS SCREWED CONNECTION: MICROBIOLOGIC AND SCANNING ELECTRON MICROSCOPE STUDY; *International Journal of Immunopathologic Pharmacology*, 20 (Suppl 1) Jan-Mar: 13-17, 2007
- Ravasini T., Malaguti G., Coppi C., Bortolini S., Consolo U.; APPLICAZIONE CLINICA DI UN NUOVO IMPIANTO CORTO; *Dental Cadmos*, 6: 57-62, 2007
- Barone A., Rispoli L., Vozza I., Quaranta A., Covani U.; IMMEDIATE RESTORATION OF SINGLE IMPLANTS PLACED IMMEDIATELY AFTER TOOTH EXTRACTION; *Journal of Periodontology*, 77 (11):1914-1920, 2006
- Barone A., Santini S., Sbordone L., Crespi R., Covani U.; A CLINICAL STUDY OF THE OUTCOMES AND COMPLICATIONS ASSOCIATED WITH MAXILLARY SINUS AUGMENTATION; *International Journal of Oral Maxillofacial Implants*, 21(11):81-5, 2006
- Covani U., Barone A., Cornelini R., Crespi R.; CLINICAL OUTCOME OF IMPLANTS PLACED IMMEDIATELY AFTER IMPLANT REMOVAL; *Journal of Periodontology*, 77:722-727, 2006
- Petrillo N.; CARICO IMMEDIATO POST-ESTRATTIVO SU MONOIMPIANTI MASCELLARI; *Dental Cadmos*, 8:37-45, 2006
- Sbordone L., Guidetti F., Menchini Fabris G.B., Sbordone C.; LANGERHANS' CELL HISTIOCYTOSIS: A CASE REPORT OF AN EOSINOPHILIC GRANULOMA OF THE MANDIBLE TREATED WITH BONE GRAFT SURGERY AND ENDOSSEOUS TITANIUM IMPLANTS; *International Journal of Oral and Maxillofacial Implants*, 21: 124-130, 2006
- Seganti P.; TORONTO IN FIBRA, UN'ALTERNATIVA MODERNA; *Quintessenza Odontotecnica*, 3:30-38, 2006
- Barone A., Crespi R., Santini S., Cornelini R., Covani U.; RIALZO DEL SENO MASCELLARE IN CASI DI SPLIT MOUTH: OSSERVAZIONI ISTOLOGICHE; *Italian Oral Surgery*, 2: 19-24, 2005
- Conseva E., Tealdo I., Acquaviva A., Bevilacqua E., Volpara G., Pera P.; ANALISI MORFOLOGICA E VALUTAZIONE DELLA PROLIFERAZIONE CELLULARE IN RELAZIONE A DIFFERENTI TRATTAMENTI DI SUPERFICIE IMPLANTARE: STUDIO IN VITRO; *Implantologia*, 4: 303-317, 2005
- Covani U., Barone A., Marconcini S., Cornelini R.; IMPIANTI POSTESTRATTIVI A PROTESIZZAZIONE IMMEDIATA. STUDIO CLINICO PRELIMINARE; *Implantologia Orale*, 5 (11): 40-45, 2005
- Pappalardo S., Baglio O.A., Carlino P., Grassi F.R.; INDAGINE AL MICROSCOPIO ELETTRONICO A SCANSIONE DI DIVERSE SUPERFICI IMPLANTARI: STUDIO COMPARATIVO; *European Journal of Implant Prosthodontics*, 1 (1): 25-34, 2005
- Riley D., Bavastrello V., Covani U., Barone A., Nicolini C.; AN IN-VITRO STUDY OF THE STERILIZATION OF TITANIUM DENTAL IMPLANTS USING LOW INTENSITY UV-RADIATION; *Dental materials; official publication of the Academy of Dental Materials*, 21 (8): 756-60, 2005
- Barone A., Ameri S., Santini S., Covani U.; GUARIGIONE OSSEA MARGINALE IN IMPIANTI POSTESTRATTIVI IMMEDIATI; *Implantologia Orale*, 5 (11): 37-40; 2004
- Barone A., Santini S., Covani U.; IMPIANTI POST-ESTRATTIVI IMMEDIATI. STUDIO LONGITUDINALE A 4 ANNI. RISULTATI PRELIMINARI; *Il Circolo, Rivista Periodica di Odontostomatologia*, 1: 7-11, 2004
- Barone A., Ameri S., Santini S., Covani U.; IMPIANTI POST-ESTRATTIVI SENZA LEMBO CHIRURGICO: GUARIGIONE DEI TESSUTI MOLLI; *DoctorOs*, 15 (3): 223-227, 2004
- Bruschi G.B.; TECNICA DI ESPANSIONE VERTICALE DELLA CRESTA EDENTULA CON DISLOCAMENTO DEL PAVIMENTO DEL SENO MASCELLARE; *Implantologia Orale*, 3 (5): 9-24; 2004
- Calesini G., Scipioni A.; RITRATTAMENTO IMPLANTARE: RIFLESSIONI SU UN CASO CLINICO; *Il Circolo, Rivista Periodica di Odontostomatologia*, 1: 21-26, 2004
- Carinci F., Pezzetti F., Volinia S., Francioso F., Arcelli D., Marchesini J., Caramelli E., Piattelli A.; ANALYSIS OF MG63 OSTEOBLASTIC-CELL RESPONSE TO A NEW NANOPOROUS IMPLANT SURFACE BY MEANS OF A MICROARRAY TECHNOLOGY; *Clinical Oral Implant Research*, 15: 180-186, 2004
- Cassetta M., Dell'Aquila D., Calasso S., Quaranta A.; LA MODULAZIONE DEI TEMPI DELLA TERAPIA IMPLANTARE. ANALISI DELLA FREQUENZA DI RISONANZA (AFR); *Dental Cadmos*, 1: 1-30, 2004
- Covani U., Barone A., Cornelini R., Crespi R.; SOFT TISSUE HEALING AROUND IMPLANTS PLACED IMMEDIATELY AFTER TOOTH EXTRACTION WITHOUT INCISION: A CLINICAL REPORT; *The International Journal of Oral and Maxillofacial Implants*, 19(4): 549-553, 2004
- Covani U., Crespi R., Cornelini R., Barone A.; IMMEDIATE IMPLANTS SUPPORTING SINGLE CROWN RESTORATION: A 4-YEAR PROSPECTIVE STUDY; *Journal of Periodontology*, 75(7):982-8, 2004
- Covani U., Bortolaia C., Barone A., Sbordone L.; BUCCO-LINGUAL CRESTAL BONE CHANGES AFTER IMMEDIATE AND DELAYED IMPLANT PLACEMENT; *Journal of Periodontology*, 75(12):1605-12, 2004
- Morra M., Cassinelli C., Crespi R., Covani U.; VALUTAZIONE IN VITRO DI UNA NUOVA SUPERFICIE IMPLANTARE CON MORFOLOGIA NANO-STRUTTURATA; *Il Circolo, Rivista Periodica di Odontostomatologia*, 1: 27-34, 2004
- Perrotti V., Scarano A., Iezzi G., Piattelli A.; RISPONDA OSSEA AD IMPIANTI A SUPERFICIE ANODIZZATA; *Il Circolo, Rivista Periodica di Odontostomatologia*, 1: 13-20, 2004
- Postiglione L., Di Domenico G., Ramaglia L., di Lauro A.E., Di Meglio F., Montagnani S.; DIFFERENT TITANIUM SURFACES MODULATE THE BONE PHENOTYPE OF SAOS-2 OSTEOBLAST-LIKE CELLS; *European Journal of Histochemistry* 49 (3): 213-222, 2004
- Bellabona G.; IMPIANTO POST-ESTRATTIVO CON INNesto DI OSSO AUTOLOGO E MEMBRANA NON RIASSORBIBILE; *Il Dentista Moderno*, 7 (9): 121-126, 2003
- Biancolini M., Brutti C.; STUDIO COMPARATIVO DEL COMPORTAMENTO MECCANICO DI QUATTRO IMPIANTI; *Relazione interna, Sweden & Martina*, 15 gennaio 2003
- Cassetta M., Vozzolo S.V., Stasolla A., Marini M.; LA RISONANZA MAGNETICA NELLA VALUTAZIONE PREIMPLANTARE; *Dental Cadmos*, 3: 19-37, 2003
- Covani U., Cornelini R., Barone A.; BUCCO-LINGUAL BONE REMODELING AROUND IMPLANTS PLACED INTO IMMEDIATE EXTRACTION SOCKETS: A CASE SERIES; *Journal of Periodontology*, 74(2):268-73, 2003
- Covani U., Barone A., Cornelini R., Gherlone E.; RADIOGRAPHIC BONE DENSITY AROUND IMMEDIATELY LOADED ORAL IMPLANTS; *Clinical Oral Implant Research*; nr. 14 (5): 610-615, 2003
- Marzo G., Di Martino S., Marchetti E., Mummolo S.; VALUTAZIONE RETROSPETTIVA DELLA METODOCA IMPLANTARE POSTESTRATTIVA: 10 ANNI DI OSSERVAZIONE; *Doctor OS*, 14 (4): 366-379, 2003
- Masolini P.; IMPIANTO POSTESTRATTIVO IMMEDIATO; *Il Dentista Moderno*, 4:115-122, 2003
- Postiglione L., Di Domenico G., Ramaglia L., Montagnani S., Salzano S., Di Meglio F., Sbordone L., Vitale M., Rossi G.; BEHAVIOR OF SAOS-2 CELLS CULTURED ON DIFFERENT TITANIUM SURFACES; *Journal of Dental Research*, 82 (9): 692-696, 2003
- Scarano A., Iezzi G., Petrone G., Quaranta A., Piattelli A.; VALUTAZIONE DELLA DENSITA' OSSEA PERIMPLANTARE: UNO STUDIO SPERIMENTALE SU CONIGLIO; *Il Dentista Moderno*, 5:95-107, 2003
- Covani U., Barone A., Cornelini R.; RIALZO DEL SENO MASCELLARE UTILIZZANDO PLASMA RICCO DI PIASTRINE E SOLFATO DI CALCIO; *Doctor OS*, 6: 725-730, 2002
- Covani U., Barone A.; IMPIANTI IMMEDIATI E PLASMA RICCO DI PIASTRINE: CASO CLINICO; *Dental Cadmos*, 10:79-85, 2002
- Cilenti C., Grasso G., Pincso S., Pulvirenti G.; SISTEMA COMBINATO PER LA CARATTERIZZAZIONE A FATICA DI MATERIALI IMPLANTOLOGICI E PROTETICI; *Relazione interna, Università di Catania*, 2001
- Conforti A., Madini G.; MONO IMPIANTI: REALIZZAZIONI PROTETICHE CON L'AUSILIO DI VETROPOLIMERI OCCLUSO FUNZIONALI; *Rassegna Odontotecnica*, 9: 33-48, 2000

  
**sweden & martina**  
[www.sweden-martina.com](http://www.sweden-martina.com)

Sweden & Martina S.p.A.  
Via Veneto, 10  
35020 Due Carrare (PD), Italy  
Tel. +39.049.9124300  
Fax +39.049.9124290  
[info@sweden-martina.com](mailto:info@sweden-martina.com)

Sweden & Martina Mediterranea S.L.  
Sorolla Center, Oficina 801  
Av.da Cortes Valencianas 58, 8pl  
-46015-Valencia, España  
Tel. +34.96.3525895  
[info.es@sweden-martina.com](mailto:info.es@sweden-martina.com)  
Numero gratuito 900993963



Rev. 03-14



Contents up to date at time of publication.  
Check with the company for any subsequent updates.